



PORSCHE



Porsche Carrera Cup Deutschland Regulations 2023



General Regulations for

Series run on Circuits / Automobile Sport

Name of the Series:

Porsche Carrera Cup Deutschland

DMSB Visa Number:

309/23

Status of the Series/Events: International

Porsche Deutschland GmbH, hereinafter called the Series Organiser, is hosting the Porsche Carrera Cup Deutschland for 2023.

Organisation: Porsche Deutschland GmbH
Porschestra. 1
74321 Bietigheim-Bissingen
Germany

Contact: Hurui Issak
Project Manager Porsche Carrera Cup Deutschland
Tel.: +49 711 911- 12381
Mobile: +49 170 911- 3168
Fax: +49 711 911- 12322

Homepage: www.porsche.de/pccd

E-Mail: hurui.issak@porsche.de

Contents

Part 1: Sporting Regulations.....	6
1 Introduction	6
2 Organisation.....	6
2.1 Details on titles and awards of the Series	6
2.2 Name of the Parent ASN	6
2.3 ASN Visa/Registration number.....	6
2.4 Contact details of the Series Organiser (Permanent Office).....	7
2.5 Organising Committee.....	7
2.6 Sporting Committee	7
2.7 List of Officials (Permanent Stewards)	7
3 Regulations and Legal Basis of the Series	8
3.1 Official Language	8
3.2 Responsibility, Changes to the Rules of Participation and Cancellation of the Event	8
3.3 General Definitions	9
4 Entries	10
4.1 Registrations/Entries, Entry Closing Date and Obligation to Participate	10
4.2 Entry Fees.....	15
4.3 Force Majeure.....	16
4.4 Competition numbers.....	16
5 Licences	16
5.1 Required Grade of Licence.....	16
5.2 Conditions for Competitors outside their National Territory	17
5.3 E-Learning.....	17
6 Insurance, Liability Exclusion and Disclaimer	17
6.1 Organiser's/Promoter's Insurance	17
6.2 Declaration by the Competitor and Driver on the Exclusion of Liability, Disclaimer of the Car Owner.....	17
7 Events*	18
7.1 Championship	18
7.2 Pre-Season Testing.....	18
7.3 Official Testing.....	18
7.4 Maximum Number of Cars authorized.....	18

8	Classification	19
8.1	Table of Points	19
8.2	Equality of Points	22
8.3	Publication of Points.....	22
9	Private Practice and Testing	22
10	Administrative Checks	22
10.1	Timetable for Administrative Checks.....	23
10.2	Drivers and Team Managers Briefing.....	23
10.3	Team Managers Meeting.....	23
10.4	Official meetings, press conferences, representation meetings	23
11	Scrutineering/Technical Checks	23
11.1	Repair, Sealing and Marking Car Parts.....	24
11.2	Timetable Scrutineering/Technical Checks	24
12	Running of the Competitions	25
12.1	Free Practice.....	25
12.2	Qualification.....	25
12.3	Starting Grid	26
12.4	Starting modes	27
12.5	Races 27	
12.6	Pre-Grid & Starting Procedure	27
12.7	Aborting or Suspending a Race.....	28
12.8	Use of Wet-Weather Tyres	29
12.9	Wet Race Procedure.....	29
12.10	Pit Stop Safety and Applicant's Responsibility when starting from the Pit Area	30
12.11	False Starts	31
12.12	Finish 31	
12.13	Maximum Number of Persons working on a Car and Safety Equipment	31
12.14	Safety Car	31
12.15	Full-Course-Yellow	32
13	Title, Prize Money and Trophies	32
13.1	Title Overall Winner.....	32
13.2	Prize Money and Trophies.....	32

14	Protests and Appeals.....	37
15	Choice of Law, Exclusion of Jurisdiction of a Court and Limitation of Liability.....	37
16	TV Rights/Advertising and Television Rights.....	38
17	Specific Regulations.....	38
17.1	Paddock.....	38
17.2	Instructions of the Series Organiser.....	39
17.3	Publication Obligation.....	39
17.4	Podium Ceremony.....	39
17.5	Stewards' Inquiries.....	39
17.6	Incidents.....	40
17.7	Penalties.....	40
17.8	The Track.....	41
17.9	Effectiveness of the Regulations and Ranking.....	42
17.10	Environmental Regulations.....	42
18	Safety.....	42
18.1	Extrication Exercise.....	42
18.2	Pit Lane Safety.....	43
18.3	General Safety.....	44
Part 2: Technical Regulations.....		46
1	Technical Series Regulations.....	46
1.1	Summary of the eligible groups/classes.....	46
1.2	Principles of the Technical Regulations.....	46
1.3	General/preamble.....	47
1.4	Driver equipment.....	47
1.5	General Regulations.....	48
1.6	Minimum weights and ballast.....	48
1.7	Emissions regulations.....	52
1.8	Noise regulations.....	52
1.9	Advertising and partnerships.....	52
1.10	Safety equipment.....	54
1.11	Fuel type and single fuel.....	54
1.12	Technical Definitions.....	56

1.13	Car Change.....	56
2	Specific Technical Regulations	56
2.1	General Information	56
2.2	Engine 57	
2.3	Power Transmission (gearbox/differential lock).....	58
2.4	Lubricant System.....	59
2.5	Brakes 59	
2.6	Wheel Suspension.....	60
2.7	Wheels (flange + rim) and tyres.....	61
2.8	Bodywork and Dimensions	64
2.9	Aerodynamic devices.....	67
2.10	Electrical equipment.....	68
2.11	Data Transfer.....	69
2.12	Miscellaneous.....	71
	Part 3: Attachments/Drawings	72
Attachment 1	- Badge regulations 2023*	72
Attachment 2	- Sticker Regulations 2023	73
Attachment 3	- Ballast weights.....	76
Attachment 4	- Differential lock ramp breakover angle.....	76
Attachment 5	- Ride height measuring points	77
Attachment 6	- Seat Padding.....	78
Attachment 7	- Timing Transponder Position	78
Attachment 8	- Rear-Wing Adjustment Positions	79
Attachment 9	- Parts Numbers	80
Attachment 10	- Alternative Z-Clamp Mounting	80
Attachment 11	- Table of Penalty Guidelines.....	81

These Regulations consist of 84 pages incl. 11 attachments.

Part 1: Sporting Regulations

1 Introduction

The Porsche Carrera Cup Deutschland Series, hereinafter called the Series, is organised in conformity with the provisions of the International Sporting Code and its appendices (the Code), the FIA General Prescriptions on circuits and the National Sporting Regulations of the DMSB. It will be run in conformity with these Sporting and Technical Regulations, the latter being in conformity with the safety prescriptions of FIA Appendix J (Art. 277).

The Series will be run according to the above regulations. For the avoidance of doubt, should there be any inconsistency or conflict between the individual sets of regulations, then the order of priority shall be firstly those of the International Sporting Code, then the Porsche Carrera Cup Deutschland Regulations, followed by the DMSB Regulations and thereafter the Supplementary Event Regulations.

The Series in 2023 consists of 16 races, held at 8 events and organised as circuit races.

The Series is supported by the following companies*:

- Michelin Reifenwerke AG & Co. KGaA
- ExxonMobil Oil Corporation - Mobil 1
- HUGO BOSS AG
- TAG Heuer - LVMH Swiss Manufactures SA
- PUMA International Sports Marketing B.V.
- Brauerei C.& A. Veltins GmbH & Co. KG

* Subject to change

2 Organisation

2.1 Details on titles and awards of the Series

Porsche Deutschland GmbH, hereinafter called the Series Organiser, is hosting the Series in 2023.

2.2 Name of the Parent ASN

DMSB – Deutscher Motor Sport Bund e. V.
Hahnstraße 70, 60528 Frankfurt-Germany
Homepage: www.dmsb.de
E-Mail: info@dmsb.de

2.3 ASN Visa/Registration number

The Series based on these Sporting and Technical Regulations has been approved by the Deutscher Motor Sport Bund on 30. March 2023 with visa number 309/23.

2.4 Contact details of the Series Organiser (Permanent Office)

Porsche Deutschland GmbH
Porsche Carrera Cup Deutschland Organisation
Porschestr. 1
74321 Bietigheim-Bissingen
Germany

Contact:

Hurui Issak
Project Manager Motorsport - Porsche Carrera Cup Deutschland
Tel.: +49 711 911- 12381
Fax: +49 711 911- 12322
E-Mail: hurui.issak@porsche.de

2.5 Organising Committee

The Organising Committee for the Porsche Carrera Cup Deutschland competition at each Series event (unless amended in the relevant event Supplementary Regulations) will be:

- Hurui Issak, Project Manager Motorsport - Porsche Carrera Cup Deutschland, Porsche Deutschland GmbH
- Dominik Sitzer, Organisation – Porsche Carrera Cup Deutschland. HEGERSPORT GmbH
- Mario König, Technical Support Delegate – Porsche Carrera Cup Deutschland, Manthey-Racing GmbH

Members of the Organising Committee may delegate functions and responsibilities where appropriate to other employees of Porsche Deutschland GmbH or Dr. Ing. h.c. F. Porsche AG, and Porsche Deutschland GmbH may nominate additional members of the Organising Committee where necessary.

The address of the Organising Committee is that of the Series Organiser (cf. 2.4).

2.6 Sporting Committee

A Sporting Committee for the Series will be established comprising of the following people or their nominated representatives:

- The Series Organiser;
- The Permanent Race Director;
- The Permanent Chairman of the Stewards;
- The Series Technical Support Delegate.

The role of the Sporting Committee will be to resolve any issues arising in respect of interpretation or application of the Series Sporting and Technical Regulations and will include taking decisions on:

- Any questions concerning points or the classification of the Series;
- Any matters arising from the Series Regulations which are not specific to an individual event.

Decisions taken by the Sporting Committee shall be final and are not subject to protest or appeal.

2.7 List of Officials (Permanent Stewards)

(see also relevant Supplementary Event Regulations)

3 Regulations and Legal Basis of the Series

The Series is governed by the following regulations:

- FIA International Sporting Code (ISC) and its appendices
- FIA General Prescriptions on circuits
- Sporting and Technical Regulations of this Series and the DMSB approved modifications and supplements (bulletins)
- DMSB Event Regulations
- DMSB Circuit Rules, except where any special regulations are set out in the rules presented here
- DMSB Licence Regulation
- DMSB Legal System and Code of Procedure (RuVO); FIA Legal Rules and Code of Procedure
- DMSB Decisions and Provisions
- DMSB Environmental Guidelines
- Anti-Doping Regulations of the National and International Anti-Doping Agency (NADA Code and WADA Code) as well as the Anti-Doping Regulations of the FIA
- Supplementary Event Regulations including modifications and supplements issued by the DMSB or the Stewards of the Event (bulletins)
- Sporting and Technical Regulations of this Series and the DMSB approved modifications and supplements (bulletins)
- The "Application for Entry" or the "Application for Guest Entry" signed by the Competitor/Driver
- FIA Code of Good Conduct and DMSB Code of Ethics
- Other FIA and DMSB regulations

3.1 Official Language

For the present regulations of the Porsche Carrera Cup only the English text approved by the DMSB is binding, except for the relating DMSB regulations specified in Art. 3 (Regulations and Legal Basis of the Series), for which only the German language is binding.

In case of interpretation the DMSB jurisdiction is the responsible authority.

The official language of the International Sporting Code is stated within that document.

3.2 Responsibility, Changes to the Rules of Participation and Cancellation of the Event

The participants (Competitors, Drivers, Passengers, Car Owners, Team Members, Registered Keepers and team guests) attend and take part in the event at their own risk. They are solely responsible under civil and criminal law for any and all damage caused by them – or for damage to the cars used by them, as far as no exclusion of liability has been concluded. The Supplementary Event Regulations may only be changed by the ASN of the event. Once the Event starts, changes in the form of bulletins may only be made by the Stewards of the event.

The Event Organiser and the Series Organiser reserve the right to cancel or relocate the event or individual races, subject to approval by the ASN concerned and the FIA where the calendar is affected. Claims for damages or performance shall be excluded in all such cases.

The Series Organiser reserves the right to adjust any of the following regulations for specific events at his discretion if circumstances of the event in question require such adjustments to secure the realisation of the series' event. Such circumstances may include but are not limited to general event requirements (e.g. timetable needs) or requirements of

the racetrack (e.g. noise limitation, car count limitation). Any adjustment regarding the following regulations needs to be approved by the DMSB via Bulletin. Any adjustment regarding specific event regulations needs to be approved by the responsible ASN of the event.

3.3 General Definitions

Porsche Carrera Cup Deutschland Code of Good Conduct

The Porsche Carrera Cup Deutschland is a Series characterised by equality of opportunity and fairness in both technical and sporting terms. All those involved in the Series, i.e. participants, officials and organisation, make a significant contribution to how the Series is perceived, both internally and by the general public and to the atmosphere in the Series through their conduct and their communication.

All those involved are responsible for conducting themselves in such a way as to uphold and safeguard in the long term the professionalism that prevails in the Series, as well as the esteem in which the Series and its participants are held within motorsport and by the general public. Moreover, fair and sporting competition represents an important safety aspect for all participants and is intended to minimise the risks involved.

For this reason, all those involved agree to acknowledge the philosophy of the Porsche Carrera Cup Deutschland and to comply with the rules of conduct of the Series.

Both on and off the racetrack, all those involved will:

- treat all participants, officials and organisers respectfully;
- follow the laws and the rules of the sport, exemplify and promote fairness together with the rules of conduct;
- neither express themselves or behave in an insulting, offensive or abusive way, nor tolerate such expressions or modes of conduct, either in direct conversations, interviews, etc. or in other communication, e. g. press releases, posts in social media, etc.;
- always behave in the interests of safety and permanently cooperate in efforts to reduce risks;
- use resources in a sustainable way, giving priority to the well-being, safety and satisfaction of others before their own personal goal;
- always comply with the purpose of the sport;
- inform those involved if their conduct is not characterised by fairness, sportsmanship, respect and tolerance;
- cooperate with all other persons involved so as to develop and improve the Series and its status further on a continuous basis.
- Respect the laws and local customs in the countries visited by the Series.

Participants who are found to have committed one or more of the following may be excluded from the Series Organiser or may be suspended by the Stewards of the Meeting from taking part in one or more competitions:

- failed to comply with the rules of conduct;
- breached any of the regulations;
- drawn attention to themselves through unsporting behaviour on and off the track;
- expressed or conducted themselves in a disrespectful way towards other participants, officials, organisers, etc.;
- ignored the specifications, instructions, meetings of the Series Organisation and/or other official bodies in the context of the Organisation and holding of an event;
- ignored agreements that have been reached (including between Teams and Drivers) and do not meet obligations of performance;
- did not act in the interests of the sport and/or the recognisable objective of undertaking the activities seriously

- in accordance with the rules that have been acknowledged;
- brought the Series into disrepute.

Specific mandatory requirements or restrictions in respect of behaviour of participants, or specific conditions of participation, may be published by the Series Organiser in order to minimise the risks of, and maximise protection against, Covid-19 infection. These will be set out in the Porsche Carrera Cup Deutschland Covid-19 Safety Procedures document (the latest version of which will be valid and available from the Series Organiser). It is essential that these requirements are followed by all participants and any breach of these requirements would be deemed a serious infringement of the Porsche Carrera Cup Deutschland Code of Conduct. Competitors (entrants) are responsible for ensuring full compliance by every person associated with their entry.

4 Entries

4.1 Registrations/Entries, Entry Closing Date and Obligation to Participate

Application for entry to the Porsche Carrera Cup Deutschland must be submitted by a Competitor using the official "Application for Team Entry" form, supplied by the Series Organiser and must be received by the Series Organiser by **28. February 2023**. If the completed "Application for Team Entry" is received later than this date, it may only be considered at the sole discretion of the Series Organiser. An extension to an already accepted application of a Competitor may be considered after the closing date. An additional "Application for Team Entry" for each respective Competitor has to be submitted in writing and requires written approval by the Series Organiser.

Each Competitor must nominate his representative in writing on the entry form. If a Competitor is unable to be present in person at the competition, he must nominate his representative(s) in writing to the Stewards. A person having charge of an entered car during any part of a competition is responsible jointly and severally with the Competitor for ensuring that the requirements are observed.

Each individual application by a Competitor must be for a minimum of two (2) and maximum of three (3) cars. If a Competitor wishes to permanently enter additional cars, he must have an additional Competitor's licence. Exceptions from this regulation are Guest entries for a fourth or more cars which may be submitted under one Competitor licence.

Applications for a single car team can be accepted at the sole discretion of the Series Organiser.

The Series Organiser will conduct a pre-selection of all entries received by **15. January 2023**. Any entry which is not backed with a completed "Application for Driver Entry" at this date will be deemed pending and therefore moved to a waiting list. No confirmation will be issued for these applications and the Series Organiser may allocate the entry slots noted in the waiting list in favor for any other Competitor who satisfies the criteria at his own discretion immediately.

The "Application for Driver Entry" supplied by the Series Organiser must be received by the Series Organiser as a supplement to the "Application for Team Entry" by **28. February 2023**.

All applications must be fully completed, signed by the Competitor licence holder and Driver (if applicable), and must be sent to the following address:

Porsche Deutschland GmbH
Porsche Carrera Cup Deutschland Organisation
Herr Hurui Issak
Porschestr. 1
74321 Bietigheim-Bissingen
Germany

The Competitor will receive a written confirmation if his entry has been accepted. The Series Organiser reserves the right to refuse an "Application for Team Entry" or "Application for Driver Entry" at his own discretion, stating the reason. There is no automatic entitlement to acceptance or participation in the Series.

The Series Organiser reserves the right to enter cars under its own "Application for Entry".

4.1.1 Permanent Drivers

A Competitor may only apply for a permanent Driver to participate in a permanently entered car.

In submitting the "Application for Driver Entry" the Driver automatically enters the Overall Driver Championship. The applicant must specifically identify if the Driver wishes also to apply for the Rookie- or ProAm Classification (subject to the stipulated requirements for these classifications).

The deadline for the receipt of an "Application for Driver Entry" by the Series Organiser is 28. February 2023. The Series Organiser may, at his sole discretion, accept an "Application for Driver Entry" that is received after this date.

In order to meet the deadlines for the receipt of an "Application for Driver Entry" it is sufficient to send the signed application by e-mail to the Series Organiser in advance. However, the original paper version of the application must be submitted immediately thereafter.

After submission of the "Application for Driver Entry" form, a change of the specified driver is not allowed. The regulation on Substitute Driver (cf. 4.1.5) remain unaffected.

In submitting the "Application for Driver Entry", the Competitor and nominated Driver confirm their full understanding of and adherence to the Sporting and Technical Regulations of the 2023 Porsche Carrera Cup Deutschland ("PCCD").

With the submitted "Application for Driver Entry" the Driver is automatically registered for the Overall Driver Classification. Every Driver must specify if they additionally wish to participate in the ProAm Classification or Rookie Classification. The "Application for Driver Entry" must be signed by the Driver and the Competitor.

4.1.2 ProAm

- a) A ProAm is a Driver without a professional motor racing background. Eligibility is based on the sporting résumé of a Driver and requires written approval of the Series Organiser.

To be eligible to participate in the ProAm classification the Driver must satisfy each of the following criteria:

- min. 30 years of age at the entry closing date (cf.4.1)
- not be competing as a Pro in any Series during the current season
- not have been competing as a Pro in any Series (other than PCCD) within the past 5 years
- not have been classified within the best 40% of the Overall Classification of the PCCD or PMSC within the past 3 years

ProAm Drivers will get the chance to participate in additional activities provided the by the Series. These activities are:

- Health Check
- Get Together

Participation is voluntary. The Series Organiser reserves the right to cancel the event at his sole discretion. There is no entitlement to replacement or conversion.

The Series Organiser reserves the right to reject or accept any application of an ProAm driver by stating credible reasons at his sole discretion.

- b) The Series Organiser reserves the right to remove the ProAm categorisation of a driver at any time during the season, if the driver's results or sporting performance indicate such.

The driver may only continue to score points in the overall classification after the decision to change his/her categorisation has been announced by the Series Organiser. All points scored in the ProAm classification by the driver in question before the change will remain valid. No amendments to existing results will be made.

A change of the driver categorisation can only be executed once per season.

4.1.3 Rookie

A rookie is a Driver participating in their first season in the Series who has participated in no more than five races of the Porsche Carrera Cup Deutschland or Porsche Mobil 1 Supercup combined in previous years.

To be eligible for participation, the Driver shall not be born before **28. February 1998**.

4.1.4 Talent Pool

The Porsche Carrera Cup Deutschland Talent Pool is the official development programme of the Series for young Drivers. Participation in this programme is optional. The Application for participation in the PCCD Talent Pool programme must be submitted by a Driver using the official "Application for Driver Entry" form, supplied by the Series Organiser and must be received by the Series Organiser by 15.01.2023 at the latest. In addition, the applicant must submit a resume of the drivers previous racing activities together with the "Application for Driver Entry" form.

To be eligible for participation and to receive the full support of the programme the Driver must satisfy each of the following criteria:

The Driver must

- be a Rookie according to Art. 4.1.3 of these PCCD Sporting Regulations or have been part of the Talent Pool in a previous season;
- not be born before **30. November 2000** or have been part of the Talent Pool in a previous season;
- be enrolled as a full season entry;
- take part in at least seven events (and at all races at these events);
- ensure peak physical and medical condition;
- have no outstanding sports disciplinary proceedings;
- not be a member of the Porsche Motorsport Junior Programme.

The programme is limited to a maximum of eight participants. The Series Organiser may offer a wildcard to an additional applicant at his sole discretion. If there are more than eight applicants for the Talent Pool programme, the slots will be allocated based on an assessment by the Series Organiser regarding the drivers' eligibility and aptitude to participate in the programme. The Series Organiser reserves the right to reject any "Application for Talent Pool Entry" by stating credible reasons at his sole discretion.

The Driver will be informed in writing whether or not he has the opportunity to participate in PCCD Talent Pool programme. The Driver and the Series Organiser will then enter into a separate agreement governing all services and obligations for the participation in the Talent Pool programme. The conclusion of this agreement is mandatory for participation.

All teams of the Talent Pool drivers must agree to provide the Cosworth data and the VBOX footage for data analysis and evaluation as required by the Porsche Talent Pool coach after each session. The Series Organiser ensures that the provided data will only be used for the specified purpose and no data and/or graphical analysis will be distributed to other drivers. However, the data and footage of any Talent Pool driver may be used and displayed for education and

comparison within the Talent Pool.

4.1.5 Substitute Drivers

A Competitor may only apply for a Substitute Driver to participate in place of a permanently entered Driver and only after the first race of the Championship. The Series Organiser reserves the right to accept Substitute Driver that shall be entered before the first race of the Championship. The Series Organiser reserves the right to charge a fee of EUR 5,000.00 plus VAT (if applicable) for the Application of a Substitute Driver before the first race of the event.

Entries for Substitute Drivers must be submitted to the Series Organiser at least ten (10) days prior to the start of the event concerned (ISC Art 2.1.7a refers) using an "Application for Driver Entry". The Series Organiser reserves the right to accept or reject an "Application for a Driver Entry" that arrives after this time limit.

Substitute Drivers may only participate with a permanently entered car in the championship with their own, not yet allocated competition number.

A Competitor may not nominate more than two Substitute Drivers for each car per season. Each additional (Substitute) Driver must be entered under the regulations for Guest Drivers of the Series.

Permanent and Substitute driver may return to participate in the championship. Even after having missed one or multiple rounds, their status as Permanent or Substitute entry will remain.

When entering a Substitute Driver for an already registered car there is no additional charge (participation fee and team catering share). The fee has already been paid upon registration.

This does not apply, when the Substitute Driver is entering with using a new car. In this case the Competitor must submit a new "Application of Entry" and a fee of EUR 3,000.00 plus VAT (if applicable) must be paid to the Series Organiser.

4.1.6 Guest Drivers

Entries for Guest Drivers for participation in single events must be submitted no later than two weeks prior to the start of the event concerned (ISC Art 2.1.7a refers) using an "Application for Driver Entry". The Series Organiser reserves the right to accept or reject an "Application for a Guest Entry" that arrives after this time limit.

Guest Drivers can participate either in a car that is entered for individual events only or in a car that has been used by a previous Guest Driver. In either case, every Guest Driver must use their own, not yet allocated competition number.

Registered Competitors and Drivers are given priority with regards to their entitlement to race.

The Series Organiser also reserves the right to permit additional entries to individual races.

4.1.7 Authorisation

With the submission of the "Application for Team Entry" and "Application for Driver Entry", Competitors authorise the Series Organiser to submit entry forms on their behalf for those events which form part of the races for the Series in 2023 Direct nominations to the promoters by the participants are not permissible.

Furthermore, the Competitor/Driver agrees that Porsche Deutschland GmbH has access to the reports and documents of the Technical Scrutineers at all times.

4.1.8 Participation in another series within the same event

Participation in one other series within the same event is permissible.

4.1.9 Driver transfers between teams

A Driver may transfer from one team (Competitor) to another during the season, but only if the Series Organiser gives its consent in writing. Any Driver wishing to transfer to another team must complete an "Application for Driver Entry" and submit it to the Series Organiser.

The Driver must use the same competition number also with the new team.

Any permanently entered Driver is permitted to continue to score points in the applicable classifications (cf. Art. 8)

It is permitted for a Driver to use a car already registered and entered by any team. However, if the Driver intends entering a new car then the Competitor must submit a new "Application of Entry" and the respective fee must be paid to the Series Organiser (cf.4.1.5).

4.1.10 Commitment to participate

Upon registration, a Competitor commits to participate with each registered car at all official testing and races (cf. Art. 7) of the Series in 2023 without exception.

4.1.11 Failure to participate in the Event

A Competitor or Driver who fails or anticipates failing to fulfil these participation requirements must inform the Series Organiser as soon as possible, providing detailed justification in written form no later than 48 hours before the start of the competition (ISC Art 2.1.7.a refers), stating any mitigating reasons.

The Series Organiser may request the Stewards to penalise a failure to comply with this deadline. The Series Organiser may accept a request for non-participation from a Competitor and/or Driver at his sole discretion.

Any failure to inform the Series Organiser or to submit justification may be deemed a contravention of these regulations. Failure to participate may result in a fine of up to EUR 3,000 plus VAT (if applicable) per car or Driver per event unless the Series Organiser has previously received and accepted a request for non-participation from the Competitor and/or Driver.

4.1.12 Teaser Testing

A team may temporarily replace a permanently entered driver with a Temporary Driver for the sake of introducing a new driver to the Series with the potential to enter the championship in the future. A new driver is herewith defined as a driver, who has not been participating in any PCCD or PMSC event before. Furthermore, a new ProAm driver will not be allowed to participate. Any driver applying for Teaser Testing must satisfy the driving standards of the Series.

This temporal driver replacement is limited to the first test session only on each Official Test Day (cf. 7.3). In all other test sessions of the Official Test Day, the car must be driven by the permanently entered Driver. Temporary Drivers are not permitted to participate in any other than the first test session, even when the first test session is cancelled for any reason.

Only permanently entered cars may be used for Teaser Testing.

The application for the Temporary Driver must be submitted to the Series Organiser using the official form stating the VIN of the relevant car. The form must be signed by the Team Manager and the Temporary Driver.

The Temporary Driver must pass all administrative, sporting and equipment checks required in these regulations. The Temporary Driver must use compatible radio equipment to make sure he receives the radio communication from the Race Director. In addition, the Temporary Driver must visit the Race Director to receive a briefing before participating. The Series Organiser reserves the right to reject any request for a Temporary Driver at his own discretion.

4.2 Entry Fees

4.2.1 Permanent Entries

The entry fees as well as any additional deposit are payable as specified on the "Application for Entry". The following registration/entry fees are payable by participants:

For the first and second car of a team: **EUR 25,500.00** plus VAT, (if applicable).

The entry fee includes:

- Participation fee for one race car for all championship rounds (value EUR 11,650.00).
- Five 3-days team catering tickets per event (value EUR 13,850.00).

The entry fee for the Porsche Carrera Cup Deutschland 2023 for the third and any further car of a team (with one or more Competitor licences) is **EUR 8,000.00** plus VAT (if applicable) for each car. The entry fee includes the participation fee for one race car for all events. The team catering is optional in this case. The optional catering services will be provided and invoiced by a third party.

The Series Organiser will issue an invoice including VAT where applicable. An invoice will be issued after the Series Organiser has assessed the individual "Application for Entry". The invoice is neither a confirmation of the "Application for Entry" nor of entry to the Series.

4.2.2 Permanent Entries - Discount for early commitment

As appreciation to the early commitment of teams to the championship, the Series Organiser grants a discount to teams, who register for a permanent entry early.

When the entry application is received by the Series Organiser by **13. January 2023**, the entry fee for **vehicle 1 and 2 of a team** (with one or more entrant licences) is **EUR 21,500.00** plus VAT (if applicable) for each vehicle.

The discounted entry fee includes the following services:

- Participation fee for one race car for all championship rounds (value EUR 7,650.00).
- Five 3-days team catering tickets per event (value EUR 13,850.00).

All entries received after the **13. January 2023** are not applicable to this discount.

The Series Organiser will issue an invoice including VAT where applicable. An invoice will be issued after the Series Organiser has assessed the individual "Application for Entry". The invoice is neither a confirmation of the "Application for Entry" nor of entry to the Series.

4.2.3 Guest Entry Fees

The registration/entry fee for a Guest entry by a registered or non-registered team to an event is **EUR 3,750.00** plus VAT (if applicable) for each car and event. The entry fee includes:

- The entry fee includes the participation fee for one race car at the corresponding event (value EUR 1,650.00)
- as well as five 3-day team catering tickets for the corresponding event (value EUR 2,100.00).

The Series Organiser will issue an invoice including VAT where applicable. An invoice will be issued after the Series Organiser has assessed the individual "Application for Entry". The invoice is neither a confirmation of the "Application for Entry" nor of entry to the Series.

Once the payment has been received by the Series Organiser and the application has been accepted, the Series Organiser will issue a written confirmation of entry. As of the issue date of the written confirmation by the Series

Organiser the entry fee is non-refundable.

4.3 Force Majeure

Force majeure, labour disputes, civil disturbances, action by official bodies and other unforeseeable, unavoidable and serious occurrences, in particular restrictions and measures due to the Covid-19 pandemic, shall release the Series Organiser from his duties to perform regarding the aforementioned scope of services. In case of cancellation of services, the Series Organiser will accordingly try to compensate the cancelled services with other services or refund a reasonable part of the entry fee to the Competitor.

4.4 Competition numbers

All Drivers entered shall be allocated with their own, not otherwise allocated competition number from 1 to 99 for the entire season. Drivers participating under Substitute or Guest entry status shall be allocated a competition number by the Series Organiser from the pool of numbers remaining. Once allocated, the competition numbers remain the same for all subsequent races of the Drivers.

5 Licences

5.1 Required Grade of Licence

5.1.1 Drivers/Substitute Drivers

Drivers holding a valid international Driver's licence for 2023 issued by an FIA-affiliated ASN, of Grades

A-Circuit, B-Circuit, C-Circuit

who are registered for the Porsche Carrera Cup Deutschland 2023 and have paid the entry fees are eligible.

Employees of Dr. Ing. h.c. F. Porsche AG and its subsidiaries are not eligible to participate.

5.1.2 Competitors

Competitors wishing to register with the Series must be in possession of a valid international Competitor's licence issued by an FIA-affiliated ASN and have paid the registration fees.

5.1.3 DMSB-Sponsor-Card

Sponsors who wish to be named in addition to the Driver's name in the official program, as well as the list of nominations, starters and results, without assuming the role of an applicant can do so by purchasing a "DMSB sponsor card for companies, clubs, teams "(Only for DMSB-sanctioned events with the exception of FIA-sanctioned events).

5.1.4 Guest Drivers

The Series Organiser may admit Guest Drivers with a valid international Driver's licence in accordance with item 5.1.1.

Guest Drivers may take part without being eligible for the points classification on condition that they comply with the conditions of the Series Regulations and of the relevant Supplementary Event Regulations. Priority in the acceptance of entries will be given to the registered Competitors.

5.1.5 Age Regulations

In accordance with the requirement of the valid DMSB License Regulations and Appendix L, ISC, Drivers must be at least 16 years old.

5.2 Conditions for Competitors outside their National Territory

DMSB licence holders and licence holders by another ASN affiliated to the FIA have the right for participation and are entitled to score points for the series.

For every competition, foreign Competitors/Drivers must present the written approval of their licensing ASN. This permission must be submitted by the Competitor/Driver at Administrative Checks in German or in English language.

5.3 E-Learning

A mandatory e-learning programme will be implemented. All Drivers and team managers must successfully complete the e-learning program before the start of the first competition of the series.

Competitors and Drivers will receive personalized login credentials after registering for the Series, which they must use to sign in and complete the e-learning program in via the following link:

<https://porsche-one-make-series-elearning.edubreak.de/>

The receipt of login credentials for the e-learning programme is neither a confirmation of the "Application for Entry" nor of entry to the Series.

All Competitors and Drivers must be familiar with the contents of the e-learning program for the duration of the series. Random repetition tests can be conducted with Drivers and team managers at any event.

6 Insurance, Liability Exclusion and Disclaimer

6.1 Organiser's/Promoter's Insurance

The insurance company and policy number will be stated in the Supplementary Regulations for each event.

6.2 Declaration by the Competitor and Driver on the Exclusion of Liability, Disclaimer of the Car Owner

In accordance with DMSB Event Regulations.

7 Events*

7.1 Championship

27. - 29.04.2023	01	FIA WEC	Spa-Francorchamps	(BEL)
09. - 11.06.2023	02	Festival of Dreams	Hockenheimring	(DEU)
23. - 25.06.2023	03	DTM	Zandvoort	(NLD)
04. - 06.08.2023	04	DTM	Nürburgring	(DEU)
18. - 20.08.2023	05	DTM	Lausitzring	(DEU)
08. - 10.09.2023	06	DTM	Sachsenring	(DEU)
22. - 24.09.2023	07	DTM	Red Bull Ring	(AUT)
20. - 22.10.2023	08	DTM	Hockenheimring	(DEU)

7.2 Pre-Season Testing

Participation is mandatory for all teams and Drivers, who are entered on a permanent entry.

12. - 13.04.2023 Pre-Season Test Nürburgring (DEU)

7.3 Official Testing

Additional official testing slots will be made available to all Competitors on Thursdays at selected events:

03.08.2023 Official Test Nürburgring (DEU)
17.08.2023 Official Test Lausitzring (DEU)
21.09.2023 Official Test Red Bull Ring (AUT)
19.10.2023 Official Test Hockenheimring (DEU)

Participation in these testing days is mandatory for all Competitors. Official testing days will be offered at conditions courtesy of event organizer/promoter. Settlement will be carried out directly with the event organizer/promoter.

*Subject to change.

7.4 Maximum Number of Cars authorized

Subject to the maximum number of permitted cars being defined in the circuit licence, the Series Organiser limits the maximum number of cars to 32 including Guest starters. Entries by the Series Organiser are excluded from the overall limit of 32.

Two (2) additional cars will be permitted to participate only in event 02 Festival of Dreams (Hockenheimring) increasing the maximum number to 34. These entry slots will be allocated by a draw among all companies permanently entered to the championship. The draw will be conducted in the second Team Managers Meeting at the first event.

8 Classification

8.1 Table of Points

The winner of a race is the participant who has driven the specified distance with their car within the shortest time, considering all penalties.

The winner of a race in regard to the awarding of points is the entered participant driving an entered car/on an entered competition number who has driven the scheduled distance with his/her car in the shortest time, taking account of all penalties.

All participants who started the race will be classified in accordance with the number of laps of the circuit covered, providing that they have completed at least 75 % of the distance covered by the winner (rounded up to the nearest whole lap). Drivers who have completed the same number of laps will be classified in the order in which they last crossed the finishing line.

If the race duration is shortened or stopped and not resumed, the participants will be awarded the points as indicated below, providing that at the time the race is stopped the leader has covered the following distance (based on the laps completed by the winner as shown in the Final Classification):

- If at least 50% of the scheduled number of race laps have been completed (rounded down to the nearest whole lap), 100% points will be awarded.
- If less than 50% of the scheduled number of race laps have been completed (defined as above), 50% points will be awarded.

If a race is stopped before the leader has finished two complete racing laps (and is therefore declared null and void) and cannot be restarted, or a race cannot be started at all, then 50% points will be awarded on the basis of the Qualifying Final Classification.

The Stewards may disallow the points awarded to any Driver and/or Competitor who they deem responsible for causing the stoppage of a race which is then declared null and void and cannot be restarted. If there has also been no Qualifying Classification, then no points will be awarded.

The race distance is the duration specified in the Supplementary Event Regulations for the race(s). No additional laps are added to the race distance, in the event of the Safety Car is used at any time in a race even if the Safety Car has been used at any time in a race.

All laps of the race circuit covered after starting the race will be counted to obtain the distance covered. The warm-up and slowdown laps do not count towards the distance.

8.1.1 Allocation of Points

Participants who satisfy the conditions for the allocation of points in the Overall Driver and Team Championship and/or Rookie and/or ProAm Classification for the individual races shall be awarded the following points in the order in which they are ranked in the final classification of each race, in accordance with the rules for the Overall Driver and Team Championship and/or Rookie and/or ProAm Classification.

	Overall, Team Championship & Rookie Classification	ProAm Classification
1st place:	25 points	25 points
2nd place:	20 points	20 points
3rd place:	16 points	16 points
4th place:	13 points	13 points
5th place:	11 points	11 points
6th place:	10 points	10 points
7th place:	9 points	9 points
8th place:	8 points	8 points
9th place:	7 points	7 points
10th place:	6 points	6 points
11th place:	5 points	5 points
12th place:	4 points	4 points
13th place:	3 points	
14th place:	2 points	
15th place:	1 point	

In addition to receiving points for the Overall Driver Championship, ProAm and Rookie Drivers receive points according to their respective table of points for their separate classification, when being classified in the final classification. For the avoidance of doubt, no other Competitor competing in a race other than permanent Competitors or Substitute Competitors are eligible to score points. No Competitor from another series competing in the same race is eligible to score points.

8.1.2 Overall Driver Classification

The Overall Driver Classification is the official Driver championship classification of the Series.

The Driver named in the "Application for Driver Entry" must take part in at least seven events (and at all races at these events) to be included in the final classification for the year.

All results of the individual races count towards the final Overall Classification at the end of the year. There are no void or 'dropped' results.

The winner of the 2023 Series is the entered Driver with the highest total number of points in the Overall Classification from all races.

8.1.3 ProAm Classification

The ProAm Classification is independent of the Overall Driver Championship and Team Championship.

The Driver named in the entry for the ProAm Classification must take part in at least seven events (and at all races at these events) in order to be included in the final classification for the year.

All results of the individual races count towards the final ProAm Classification at the end of the year. There are no void or 'dropped' results.

The winner of the ProAm Classification is the entered Driver with the highest total number of points in the ProAm Classification from all races.

For the ProAm Classification to take place, a minimum of three and maximum of twelve applicable Drivers must have

permanently entered the Series. The slots will be allocated on a first come first serve basis.

8.1.4 Rookie Classification

The Rookie Classification is independent of the Overall Driver Championship and Team Championship.

The Driver named in the entry for the Rookie Classification must take part in at least seven events (and at all races at these events) to be included in the final classification for the year.

All results of the individual races count towards the final Rookie Classification at the end of the year. There are no void or 'dropped' results.

The winner of the Rookie Classification is the entered Driver with the highest total number of points in the Rookie Classification from all races.

8.1.5 Substitute Drivers

Substitute Drivers will be awarded points according to their results (Overall Driver Championship, ProAm or Rookie Classification).

8.1.6 Guest Drivers

Guest Drivers (including "Porsche AG" entries) will not be awarded points but may participate in any podium ceremonies as applicable. Drivers classified behind Guest Drivers in the race results from an event will move up within the points ranking accordingly.

8.1.7 Team Classification

The Team Classification is independent of the Overall Driver Championship. The points of two cars entered under the same Competitor licence are added for the team ranking. Points for the Team Championship are awarded according to the official overall race result, irrespective of classification.

If there are more than two cars entered under one Competitor licence, the two highest scoring cars per Competitor count for the Team Championship of the individual race. No other cars from the same Competitor will be considered for the Team Championship. Cars from other Competitors will move up within the points ranking accordingly.

Team Championship points will be awarded in accordance with the 'Allocation of Points' as set out in Art. 8.1 Table of Points.

If a **Substitute Driver** takes part in a car registered in the Series, the Competitor will receive the points in the Team Championship achieved in accordance with the result in the race.

Results of **Guest Drivers** will not count towards the Team Championship of the Series. Drivers classified behind Guest Drivers in the race results from an event will move up within the points ranking accordingly.

8.1.8 Team Change

It is permitted for a Driver to change teams during a season and to continue scoring points for the Overall Driver Championship and the ProAm or Rookie Classification.

8.1.9 Fastest Race Laps

The Driver who has achieved the highest number of fastest race laps of all events will win this classification. If the highest number of two or more Drivers is equal, the decision is based on the Overall Driver Championship.

In cases, in which a subsequent correction needs to be carried out by the series organiser after the publication of the championship and/or series classification due to an obvious error or mistake, this can be done by the Series Organiser. Complaints regarding the series classification shall be addressed to the Series Organiser. No appeal against the decision of the Series Organiser will be accepted.

8.2 Equality of Points

- a) Points for all the positions which are tied will be added together and shared equally.
- b) If two or more Drivers set identical fastest lap times in the same race, priority will be given to the one who set it first.
- c) If there is a tie of positions in the championship classifications at any time, the positions will be determined by the highest number of first place results, then second place results and so on achieved at the given time during the 2023 Series in the championship classification in question until the tie is resolved.
- d) If, after application of this rule, a tie remains, the decision is made based on the better result of the final race.

8.3 Publication of Points

Points standings will be published by the Series Organiser in an official Team Information communication after the end of each event.

Should an error in any classification require a correction to be made after publication, this can be done by the Series Organiser. Any questions or complaints concerning the Series classifications must be submitted in writing to the Series Organiser and be received within seven days of the first publication of the points or prizes concerned.

The points and prizes classifications will be considered final seven days after the end of the last event of the season and, subject only to any ongoing judicial or sporting matters, from that time no further amendments or corrections will be made. In case of any disputes concerning point or prize attributions, these will be decided by the Series Organiser. Decisions of the Sporting Committee will not be subject to protest or appeal.

9 Private Practice and Testing

There is no restriction on private practice or testing.

10 Administrative Checks

The Competitor and Driver must ensure that all the necessary documents as set out in the Series Organiser's rules of participation are submitted by the correct date and time for licence verification. Failure to comply with this requirement may result in disqualification from the event. The following documents must be presented by the Driver/Competitor:

- Competitor's licence
- Driver's licence
- Possible ASN confirmation (if required)
- Medical aptitude form
- Authorisation to take part in events abroad

The requirement for completion of administrative checks and licence verification applies to all race events and official season tests.

The Series Organiser's information board serves as the official medium for announcements.

10.1 Timetable for Administrative Checks

See relevant Supplementary Event Regulations or official information board.

10.2 Drivers and Team Managers Briefing

The time and location of the Drivers' meeting/briefing will be published in the Supplementary Event Regulations of the event.

Participation is mandatory for all Competitors and Drivers. An established non-attendance or incomplete attendance (according to the list of signatures) results in a fine of EUR 200,00 being imposed by the Stewards (without any particular penalty-procedure). Any attendance of Competitor's representative or Driver operating a mobile device (phone, tablet, etc) during the briefing will be deemed incomplete and will be referred to the Stewards.

The Season Briefing notes and the event specific notes and presentation material issued by the Race Director are formal documents which must be complied with.

10.3 Team Managers Meeting

The time and location of the Team Managers meetings are specified in the internal event schedule. Participation is mandatory. Any non-attendance or late attendance (according to the list of signatures of attendees) may incur a penalty. Any instructions issued at the Team Managers' meeting must be complied with. For every Competitor license only the team manager indicated in the "Application for Entry" may participate. If the team manager cannot participate in the team managers' meeting, they can send a Substitute who is authorised to represent. Any Substitute must be announced in writing as soon as possible, but no later than the start of the administrative checks of the respective event.

10.4 Official meetings, press conferences, representation meetings

The time and place for all official meetings, press conferences and representation meetings (autograph session, photoshoots, etc.) are specified in the internal event schedule. Any established non-participation or incomplete participation (according to the sign-on sheet) may result in a fine of EUR 200,00 imposed by the Stewards.

11 Scrutineering/Technical Checks

Before and as required, during each event all cars will be inspected by one or more Technical Scrutineers licensed by an FIA-affiliated ASN. The names of the Technical Scrutineers will be stated in the Supplementary Event Regulations or in a Stewards Bulletin. They may be provided by the promoter or by the Series Organiser. Any car can be selected at any time by the Stewards for a further technical examination, including examination outside the event venue. The Technical Scrutineers are entitled to check any aspects of the cars in competition at any time during the event and may conduct checks without prior request from the Race Director or the Stewards.

The Technical Scrutineers may require a car or parts of it to be dismantled by the Competitor to verify the conditions of eligibility or conformity are fully satisfied. Competitors must supply the Technical Scrutineers with the parts and samples necessary. If the scrutineering of a part requires a testing which leads to destruction or the loss of usability of the part, the Series Organizer will reimburse the costs for the part, if the result of the test clearly returns no breach of rules by the Competitor.

The Technical Scrutineers are responsible for the operation of the Parc Fermé and are the only persons authorised to give instructions in this respect to the Competitors. Competitors and Drivers shall at all times follow the instructions of the Technical Scrutineers regarding the checking and re-inspection of cars.

11.1 Repair, Sealing and Marking Car Parts

See Part 2: Technical Regulations.

11.2 Timetable Scrutineering/Technical Checks

11.2.1 Scrutineering before the Start of an Event

Before the commencement of each event, the Competitor must present his race car and the Driver must present the compulsory Driver's safety equipment at Technical Scrutineering at the published times. The car must be presented in the configuration as it will be used in the competition (including competition numbers and advertising) and it is the Competitor's responsibility to ensure that the car fully complies with the applicable Technical Regulations at all times throughout the event, commencing with pre-event scrutineering. The presentation of a car for scrutineering will be deemed an implicit statement of conformity.

The following car documents must be presented with the car to the Technical Scrutineers:

- Technical passport
- Certificate for rollover structure

The cars and Drivers' safety equipment are to be shown to the Technical Scrutineers for technical and visual examination during the stated inspection periods. The inspection periods are to be strictly adhered to.

Once pre-event Technical Scrutineering is completed, the cars may only leave the paddock with the permission of the Series Organiser. Any car that is permitted to leave the paddock must be presented again to the Technical Scrutineers before taking any further part in the event. It is the Competitor's responsibility to present the car to the Technical Scrutineers.

No car may take part in an event until it has been passed by the scrutineers.

Unless a waiver is granted by the Scrutineers or Stewards, Competitors who do not keep to the set time limits will not be permitted to take part in a competition.

11.2.2 Scrutineering during an Event

After qualifying and each race, the cars are to be brought to the Parc Fermé area by the route described in the Drivers' Briefing. The Parc Fermé area of the Series will be identified in the Supplementary Event Regulations for each race event or in the notes from the Drivers' Briefing. The route from the finish line to the Parc Fermé is subject to the Parc Fermé provisions. All cars must be driven by the relevant Drivers in full racing equipment to the Parc Fermé after qualifying and racing; this does not apply to the Technical Scrutineers and their assistants or nominated Drivers for podium cars in accordance with article 17.5.

All cars are subject to Parc Fermé conditions until the end of the protest period and until released by the Technical Scrutineers or the Stewards. During this time, no works of any kind may be performed on the cars. Once in the designated area, no car may be removed without the permission of the Technical Scrutineer / Race Director. No individual may enter Parc Fermé without the permission of the Technical Scrutineers.

Cars that have been involved in an accident at any time during an event are to be presented to the Technical

Scrutineers. Any repairs to be made, as determined by the Technical Scrutineers, must be undertaken by the Competitor and the car must be represented to the Technical Scrutineers. It is the Competitor's responsibility to do so before taking part in the event again.

The Stewards, Race Director or the Chief Medical Officer can require a Driver to have a medical examination at any time during an event.

Any car that is permitted to leave the paddock for repairs after an incident must be presented again to the Technical Scrutineers before taking any further part in the event. It is the Competitor's responsibility to present the car to the Technical Scrutineers.

An engine or gearbox change must be approved in advance by the Series Organiser in writing.

The Technical Scrutineers will publish the results for each car scrutineered. These results will not include any specific figures or data except where a car is found to be in breach of the technical regulations.

12 Running of the Competitions

12.1 Free Practice

One or more free practice sessions will be scheduled for each event. The total duration of all free practice sessions will be at least 60 Minutes.

The free practice session time duration may be reduced in length should it be temporarily stopped for reasons of safety or Force Majeure.

Any Driver causing a session to be stopped may be referred to the Stewards and may receive a penalty.

The order of the cars in the pre-grid for all free practice session is determined by the result of the preceding race. For the first pre-grid of the season, the order of the cars will be determined by a draw. Substitute Drivers will inherit the rank from the competition number they are replacing. Guest Drivers will be placed at the back in the order of their competition numbers.

12.2 Qualification

One qualifying session will be held at each event of 35 minutes duration. All participants must qualify for the respective race. Admission to the starting grid and the races is dependent on the result of the qualifying session and the maximum number of cars according to the requirements of the circuit licence.

If the number of cars entered for an event exceeds the number of cars, which are permitted to participate in a race according to the circuit licence, the cars eligible to start the race will be determined by the result of the respective qualifying session. Cars classifying worse than the maximum number of cars eligible to race on the circuit in question will not be permitted to participate in the race. If a car which has qualified for the race is unable to participate in the race for any reason, succeeding cars may fill in according to the qualification classification.

At the end of the qualification, all cars which participated in the qualification are subject to the Parc Fermé rules.

A Driver will be admitted to a race by participating in the qualifying session and achieving a qualifying time not exceeding 107% of the fastest Driver in the qualifying session.

No Driver may start a race without having taken part in a qualifying or free practice session unless authorised by the

Stewards in consultation with the Race Director.

Any Driver failing to meet the qualifying criteria and wishing to participate in the race must make a written application to the Race Director. Admission of Drivers who have not qualified will be considered by the Stewards in consultation with the Race Director. If a Driver is unable to set a meaningful lap time in qualifying, one factor which may be considered is whether the Driver set a suitable lap time in the Practice session. However, neither the Stewards nor the Race Director are under any obligation to accept any application from any Driver who has not met the qualifying criteria and their decision in this respect is not subject to appeal.

Any Driver causing a session to be stopped may be referred to the Stewards and may receive a penalty.

The order of the cars in the pre-grid for qualification is defined by the fastest lap achieved in all free practice sessions of the respective event.

Should circumstances force the cancellation of all free practice sessions, the order of the cars for qualification will be defined by the results of the preceding race of the current season. In this case Substitute Drivers will inherit the rank from the competition number they are replacing. Guest Drivers will be placed at the back in the order of their competition numbers.

Should circumstances force the cancellation of the qualification session, then the fastest laps achieved in any free practice session of the event will be used to determine the starting grid. The fastest free practice lap of the Driver in question determines the position on the starting grid for race 1, while the second-fastest free practice lap of the Driver in question determines the position on the starting grid for race 2.

Should circumstances force the cancellation of both the free practice session and the qualification session, then the current championship positions at the beginning of the event will be used to determine the starting grid for the race and for the second race and any additional race. For the first event of the season, the order of the cars will be determined by a draw, Guest Competitors will be placed at the back in the order of their competition numbers.

12.3 Starting Grid

The starting grid for the races will be determined by the fastest times achieved in qualifying. The fastest lap times of each Driver relevant for their starting position in each race will be published after the qualifying.

The fastest time determines the starting grid for race 1. In case that two or more Drivers have the same lap time, the Driver who achieved the time first will get the better position.

The second fastest time determines the starting grid for race 2. In case that two or more Drivers have the same lap time, the Driver who achieved the time first will get the better position.

If one or more than one Driver has not set a lap time (for reasons other than cancellation of the qualifying session), these Drivers will be placed at the end of the starting grid in the following order:

- 1) the Drivers who have started a timed lap from the pit lane, in the order of their best time in free practice;
- 2) the Drivers who have not started a timed lap from the pit lane, in the order of their best time in free practice.

Drivers whose entire lap times were cancelled by decision of the Race Director or the Stewards must in all cases start the race at the end of the starting grid. Should more than one Driver have his/her entire times removed, their starting positions at the back of the grid will be determined by their best time of the cancelled lap times in free practice.

12.4 Starting modes

All races will be a standing start with staggered formation (GP start) subject to the wet race procedure.

12.5 Races

The 2023 Series consists of 16 races, held at 8 events organised as circuit races.

The length of the races will be 30 minutes plus one lap.

The number and length of races may be adjusted in the Supplementary Event Regulations.

The finish line applies both to the track and to the pit lane.

If a race is cancelled because of force majeure or for safety reasons, the Series Organiser reserves the right to reduce the number of races or to designate a replacement event. The Series Organiser is under no obligation to reschedule a race in its original format within an event.

12.6 Pre-Grid & Starting Procedure

- a) The pre-grid is the line-up of all cars before entering the circuit for the free practice, qualifying and races.
- b) For Free Practice and Qualifying the order of the cars in the pre-grid is determined by the result of the previous session. For the Races the order of the cars in the pre-grid is determined by the starting grid for the relevant session. Cars must be driven from the pre-grid area to the starting grid using the route described in the Drivers' and Team Managers' Briefing. Driving one or more laps and through the pit lane is not permitted unless specifically ordered by the Race Director.
- c) All cars must be driven from the team awning/pit to the official pre-start by the relevant Driver. Any permitted exceptions will be announced by the Series Organiser at the start of an event. All Drivers must be ready for collection in full racing clothing in their team awning/pit at the time defined in the schedule. Should a Competitor or Driver not be ready in time he/she may forgo the right to take part in the relevant session. The final decision on participation in the session is taken by the Race Director.
- d) Any car unable to leave the pre-grid area and enter the track with the rest of the cars will be given a further minute (60 seconds) to leave the pre-start area and proceed to the grid. After this time, any car which has not left the pre-grid will not be permitted to take up its position on the starting grid and must start from the pit lane if able to do so and if track access routes allow.
- e) At circuits where cars are instructed to go directly from the pre-start area to their respective positions on the starting grid, any car which instead enters the pit lane must start the race from the pit lane.
- f) At circuits where the cars are instructed to drive through the pit lane and complete a full lap before taking up their starting positions on the grid, any car that stops at its pit area during the pit lane transit or re-enters the pit lane when approaching the grid must start the race from the pit lane.
- g) On display of the 3-minute signal and/or any audible signal, all competing cars must be standing on their wheels on the track and must not be lifted again.
- h) On display of the 1-minute signal and/or audible signal, all personnel must clear the grid.
- i) At the end of the countdown, all cars on the starting grid will begin the Formation Lap. Cars in the pit lane are not permitted to participate in the Formation Lap. For safety reasons, the Race Director can allow a participant waiting at the pit exit to join the formation lap in the last position. This position also applies to the start. There will be one

Formation Lap prior to each race unless, under exceptional circumstances, the Race Director instructs two or more Formation Laps.

- j) If a car cannot start the Formation Lap, the Driver must make himself known by means such as flashing the head lights, waving his arm etc. If the Driver can restart the car and leaves the starting grid under his own power before he has been overtaken by the last competing car, then the Driver must not overtake any cars but must maintain position during the Formation Lap. At the end of the Formation Lap, the Driver may resume his original starting position on the grid.
- k) If the car is restarted under its own power, or is pushed by marshals, and then joins the Formation Lap after the last competition car has passed it, then the Driver must remain at the back of the starting field and take up the last starting position. The space on the grid must not be made up by other cars.
- l) If a car cannot start under its own power or with the assistance of the marshals, then it will be pushed into the Pit Lane by the marshals. If the Driver can restart the car, then he must wait in the Pit Lane until the race has started and then may join the race once the last car has passed the Pit Lane exit.
- m) At the end of the Formation Lap, all cars shall promptly take up their grid positions. Once stopped in their grid positions, cars must not move until the race start signal is given.
- n) The Starter will use the Formula 1 light sequence (if available) to start the race.
- o) Should a Driver be in an incorrect position on the grid or move forward from his grid position before the race start signal is given (red lights out), this may be recorded as a 'False Start'.
- p) If a Driver has a problem on the grid after the Formation Lap then he must make this known to the Starter, by means such as flashing the head lights, waving his arm, etc. If the Starter decides to delay the start, the yellow flashing lights will be switched on. Then the green lights will be illuminated, and Drivers must complete a further Formation Lap. The Driver that caused the Delayed Start will be pushed into the Pit Lane and will, if able, become a Pit Lane Starter. The race distance will be reduced by 3 minutes each time this occurs.

12.7 Aborting or Suspending a Race

After the signal to stop the race has been given, all cars able to do so will proceed directly but slowly to the grid or to another position on the track as directed by the Race Director.

If a race is aborted or stopped before the leading car has finished 2 complete racing laps, the following rules will apply:

- The start will be declared a "No Contest", however penalties may be imposed for any breaches of the regulation during the aborted/stopped race and at the discretion of the Stewards (e.g. where the breach has affected another competitor) these may be applied to the restarted race.
- Cars may be worked on but only in the Pits. Any car in the pits may start the race from the pit lane after all cars have started the race.
- If all cars are directed into the pit lane when the red flag is shown, cars may only be worked on if they go to their own pit area. Any car which goes to its own pit area will be permitted to start the race from the pit lane after all cars which remained in the fast lane have started the race.
- Retired Competitors unable to take part in the restart of the race in their original car will be classified as non-starters.
- All Drivers having taken the original start shall be eligible for the restart in their original car (subject to judicial procedures).
- The length of the restarted race will be the scheduled race distance less at least two laps (each 3 minutes of

length) – the revised distance will be defined by the Race Director in consultation with the Stewards.

- The grid for the restart will be the original starting grid.
- Empty starting places on the grid, caused by Drivers unable to restart, will not be filled. Starting rows will be filled by moving up.
- Refuelling is prohibited.

If a race is aborted or suspended after the leading car has finished two complete racing laps, the race shall be deemed to be in two parts, the first of which finished when the leading car crossed the Timing Line for the penultimate time before the race was stopped.

- The length of the second part will be the original race distance less the number of laps completed by the leader in race one and less two further laps.
- The grid for the second part will be a standard grid with the cars arranged in the order in which they finished the first part. Gaps on the grid will be made up.
- The Race Director may decide that the second part of the race will start behind the Safety Car for operational or safety reasons, in which case this may commence from the pit lane if all cars were directed there.
- The countdown for the start of the second part will commence with the 5-minute signal unless the Race Director decides otherwise.
- Only cars which took part in the first start will be eligible and then only if they returned to the grid or pits under their own power by an authorised route.
- No spare cars or reserves will be eligible.
- No refuelling will be permitted.
- Cars may be worked on but only in the Pits. Any car which entered the pit lane after the race was suspended or was pushed from the track to the pit lane will get a drive through penalty. All these cars must remain in the pit lane until the race is resumed and may only leave after all the cars behind the Safety Car have passed the pit exit.
- If all cars are directed into the pit lane when the red flag is shown, cars may only be worked on if they go to their own pit area. Any car which goes to its own pit area will be permitted to start the second part of the race from the pit lane after all cars which remained in the fast lane have started.
- The classification of the race will be the order of finishing of the second part.

If a race is aborted or suspended after the leader has completed more than 50% of the scheduled racing laps (rounded up to the next whole lap), at the Race Director's sole discretion the race may not be restarted.

If a race is stopped before the full distance or time has been achieved and the race is not restarted, then the results will be declared on the basis of the classification order when the leading car crossed the Timing line for the penultimate time before the race was stopped.

Any Driver causing a race to be stopped may be reported to the Stewards and may be subject to penalty up to disqualification from the race.

12.8 Use of Wet-Weather Tyres

See Part 2: Technical Regulations Art. 2.7.

12.9 Wet Race Procedure

1. A wet race or wet track is announced based on a decision by the Race Director/Clerk of the Course by displaying the "wet race" or "wet track" board (messages will also be displayed on the electronic timing screens where

possible). Once a wet race or wet track is announced, the teams and Drivers are free to choose slick tyres or wet-weather tyres at any time.

2. In all cases, once the cars have left the paddock area and taken position in the pre-start, the pit crew equipment and tyre trolleys will go from the paddock into the pit lane.
3. If a wet race or wet track is displayed or announced before the race starts, the start process is subject to the following conditions:

12.9.2 During the pre-start procedure

- i. The Race Director will confirm where tyres may be changed and the procedure for doing so.
- ii. The normal start procedure will then begin from the 5-minute signal. If the weather conditions continue the Race Director may elect to start the race behind the Safety Car.

12.9.3 During the start process (on the grid) before the formation lap

- i. The Competitors are shown the Start Delayed board.
- ii. The Race Director will decide where teams may change tyres and issue instructions accordingly.
- iii. The normal start procedure will then begin from the 5-minute signal. If the weather conditions continue the Race Director may elect to start the race behind the Safety Car.

12.9.4 During the Formation Lap

- i. The start is aborted.
- ii. The Race Director will decide where teams may change tyres and issue instructions accordingly.
- iii. The normal start procedure will then begin from the 5-minute signal. If the weather conditions continue the Race Director may elect to start the race behind the Safety Car.

If the start or re-start of the race is made behind the Safety Car, due to the weather conditions then the use of wet-weather tyres is compulsory until the Safety Car has returned to the Pits unless the race director also gives the explicit permission to use dry weather tyres. The start or re-start may also be from the Pit Lane.

A race will not be stopped in the event of rain unless the circuit is blocked, or the Race Director considers it unsafe to continue.

12.10 Pit Stop Safety and Applicant's Responsibility when starting from the Pit Area

The outer (fast) lane must be kept unobstructed to allow safe passage of cars at all times. The responsibility shall be on all Drivers to take due care and drive within the Pit Lane speed limit. All equipment must be kept in a safe position towards garages as soon as cars leave their pits at the start of and during practice, qualifying and races.

Competitors, team members and Drivers are responsible for the conduct and safety of their guests in the Pit Lane area. Guests must carry the correct credentials at all times. Any guest found in the Pit Lane without the correct pass will be excluded from the Pit Lane and the Competitor will be reported to the Stewards.

Competitors, team members and Drivers must ensure that their guests respect the Pit Lane regulations and be vigilant at all times. To this end, it is the responsibility of each Competitor and/or Driver to give a briefing to each individual guest regarding Pit Lane safety.

12.11 False Starts

The Race Director and/or the Stewards may use any video or electronic means to assist him in reaching a decision regarding false starts.

12.12 Finish

1. The end-of-race signal will be given at the Control Line as soon as the leading car has covered the full scheduled race distance or has covered the greatest distance within the scheduled race time.
2. Should for any reason (other than when a race is aborted or suspended in accordance with Article 12.7) the end of-race signal be given to any other car than the leading car before the leading car completes the scheduled number of laps, or before the prescribed time has been completed, the race will be deemed to have finished at the moment the leading car last crossed the Control Line before the signal was given.
3. Should for any reason (other than we race is aborted or suspended in accordance with Article 12.7) the end of the race signal will be given to the leading car before it completes the scheduled number of laps, or before the prescribed time has been completed, the race will be deemed to have finished at the moment when the leading car crossed the line.
4. Should the end-of-race signal be delayed for any reason, the race will be deemed to have finished when it should have finished.

After receiving the end-of-race signal all cars must proceed on the Circuit directly to the Parc Fermé without stopping and without any assistance (except that of the marshals, if necessary).

Any classified car which cannot reach the Parc Fermé under its own power will be placed under the exclusive control of the marshals or the Technical Scrutineers who will take the car to the Parc Fermé.

The control (timing) line applies both to the track and to the pit lane, except for the end of the race where a Competitor must take the chequered flag on the track in order to be classified for that lap.

12.13 Maximum Number of Persons working on a Car and Safety Equipment

N/A

12.14 Safety Car

The Safety Car will be deployed under the instruction of the Race Director to neutralise a race. This will be deployed in accordance with Article 2.10 of Appendix H to the FIA International Sporting Code, varied only in respect of the flag signals shown at the end of the intervention period and the pit lane exit lights. If necessary the position of the safety car can vary. If the start/finish straight is completely blocked, an electronic arrow board or sign will indicate that cars should follow the Safety Car through the pits.

The Safety Car procedure will be that firstly, waved yellow flags with stationary 'SC' boards will be displayed around the circuit. All cars must slow down immediately – overtaking is prohibited. The Safety Car will then be deployed to pick up the leader and all cars must remain no more than 5 car lengths apart. The green light at pit lane exit will remain green. During the time the safety car and the line of cars following are passing the pit lane, the pit exit light will switch to red.

Once the Race Director calls in the safety car, its orange lights will be extinguished; this will be the signal that it will be entering the pit lane at the end of that lap. At this point, the first car in line behind the safety car may dictate the pace and, if necessary, fall more than five car lengths behind it. In order to avoid the likelihood of accidents before the safety

car returns to the pit lane, from the point at which the lights on the car are extinguished, drivers must proceed at a pace which involves no erratic acceleration, braking, or any other manoeuvre which is likely to endanger other drivers or impede the restart.

As the safety car is approaching the pit entry, the yellow flags and SC boards at the marshal posts will be withdrawn and replaced by waved green flags until the last car has crossed the line.

Should the Safety Car enter the pit lane during the last lap of the race then the yellow flags will continue to be displayed at the marshals' posts.

A Driver is not permitted to overtake another car until his car has reached the control (timing) line.

12.15 Full-Course-Yellow

For safety reasons, the Race Director may initiate the Full-Course-Yellow (FCY) procedure to neutralise a session.

When the FCY procedure is engaged, waved yellow flags and FCY boards or equivalent digital FCY signage will be displayed at all marshal posts. Additionally, a message signalling FCY will be shown on the car's dashboard.

Cars must maintain a maximum speed of 80 kph while the FCY procedure is engaged. Any overtaking is strictly prohibited unless a car slows down with an obvious problem.

Any car being driven unnecessarily slowly, erratically or in a potentially dangerous manner whilst FCY is engaged, may receive a penalty.

13 Title, Prize Money and Trophies

13.1 Title Overall Winner

The Driver who has scored the highest number of points in the Overall Driver Championship after all respective race events of the 2023 Series will be awarded the title:

"Porsche Carrera Cup Deutschland Meister 2023"

13.2 Prize Money and Trophies

13.2.1 Prize Money

The prize money is paid by the Series Organiser exclusively to the Competitors (entrants).

Prize money is awarded at each event for positions 1 to 10 (Overall Driver Championship) and for positions 1 to 5 (ProAm Classification) of each official race result.

Competitors that have not taken part in all championship events with a permanently entered car will forfeit any prize money awarded in the races in which the car participated in. Cars classified after such cars do not move up the prize money system.

Substitute entries are entitled to receive prize money.

Guest entries are not entitled to receive prize money. Cars placed after such Guest cars move up the prize money system accordingly.

Cars racing under the "Porsche AG" entry are excluded from receiving any prize money. Cars placed after such Guest cars move up the prize money system accordingly.

The prize money will be paid approximately six weeks after the publication of the official final championship standings of the Series. In each case, the prize money will be paid to the Competitor named in the entry, provided that the Competitor/Driver does not owe outstanding amounts to Porsche AG and its subsidiaries, all entry conditions and conditions of participation have been adhered to and no sports disciplinary proceedings are outstanding that could influence the final tally of points.

13.2.2 Prizes in Kind

The Series Organiser can also remunerate the Drivers with a prize in kind for their successful participation.

13.2.3 VAT

The prize money and the prizes in kind are generally not classified as an exchange of supply or services from a VAT perspective.

If a remuneration is paid to the Driver in addition to the prize money/prize in kind the prize money/prizes in kind may be classified as a consideration by Series Organiser to the Drivers for their successful participation as part of an exchange of supply or services from a VAT perspective.

Generally, the prize money is paid net. If the prize money is part of an exchange of supply or services as described above the prize money is paid plus VAT if VAT should arise according to the applicable VAT law. Any applicable VAT shown on the invoices for the prizes in kind must be paid by the Driver to the Series Organiser. Only if for the supplied service of the Driver also German VAT becomes due and is credited in the self-billed invoice of the Series Organiser, no payment of VAT is due. In order to check if VAT is to be charged as per the applicable VAT law, the Drivers confirm their status as entrepreneurs for VAT purposes by indicating their tax number, resp. VAT identification number. The Driver will issue an invoice in line with the applicable law to Series Organiser. Upon request by the Driver and after providing a valid VAT registration number to Series Organiser, Series Organiser will issue a credit note to the Driver.

In case the Competitor (entrant) receives prizes in kind in addition to a supporting payment, which is paid for participating with at least one Driver who is a Reigning Champion, the ProAm Champion, the Rookie Champion of the previous year or a Porsche Junior, the Parties assume the following VAT treatment to the prize in kind:

Prizes in kind in its net amount (exclusive of VAT) is the consideration remunerated by the Series Organiser in return for the successful participation of the Driver with the highest number of Overall Classification points (barter transaction according to Sec. 3 Para. 12 sentence 2 German VAT Law). Thus, an exchange of supply and consideration takes place between the Series Organiser and the Driver.

The Driver must indicate if he acts as a non-entrepreneur or an entrepreneur for VAT purposes. If he acts as an entrepreneur for VAT purposes, he must indicate his tax number or VAT identification number.

The Series Organiser issues invoices for the supplied prizes in kind plus VAT, if applicable. In return, the Participant has to issue invoices to the Series Organiser for his successful participation according to local VAT law, plus VAT if applicable.

Any applicable VAT shown on the invoices of the Series Organiser for the prizes in kind must be paid by the Driver to the organiser. Upon request by the Participant and after providing a valid VAT registration number the Organiser will issue a credit note to Participant with regard to the services provided. Any VAT legally due is shown separately on the credit note. The addresses as shown in this Agreement will be used as invoice address.

13.2.4 Withholding Tax

All amounts stated in the contract are inclusive of any tax deductions.

If Porsche is obliged pursuant to Section 50a of the German Income Tax Act (EStG) to withhold and pay withholding tax for the account of the Competitor in respect of remuneration, means the prize money, also team prize money & special prizes, supporting payments or other non-cash benefits paid or granted to the Competitor under this agreement, Porsche shall be entitled to deduct the relevant amounts from the payments to be made to the Contractor. This shall apply even if it is doubtful whether the conditions for the tax deduction are fulfilled. The contracting partner shall bear all withholding taxes for which it is liable.

The same applies if a tax deduction is to be made under foreign law.

Tax is generally withheld on the total remuneration. However, tax shall be deducted in accordance with the following apportionment.

The remuneration will be split as follows:

- 20% royalties, 15.825% withholding taxes on every race, no matter where performed
- 80% activity through races, 15.825% withholding taxes if race is performed in Germany.

The Contractor shall ensure that the individual service components are shown separately in the invoice in accordance with the above breakdown.

If the withholding taxes to be withheld by Porsche exceed the payments to be made to the Competitor, the Competitor shall be obliged to pay the excess amount to Porsche in advance or to reimburse Porsche as soon as Porsche has requested the payment from it in writing. This shall apply mutatis mutandis to withholding taxes in connection with the granting of prizes in kind and other non-cash benefits, and in the event that the Competitor have divided the remuneration for the purposes of tax deduction and the tax amount is subsequently adjusted.

When paying out the remuneration, Porsche will only take account of any benefits under a double taxation agreement if the Contractor has received a certificate of exemption from the Federal Central Tax Office and has presented it to Porsche before payment of the remuneration (section 50c (2) sentence 1 number 1 of the German Income Tax Act).

13.2.5 Overall Driver Championship

Participants who satisfy the conditions for claiming their successes in the prize money classification for each race are awarded the following prize money in the order in which they are placed, in compliance with the regulations for prize money classification. Prize money for races is paid on a per race basis for each race that is finished, regardless of the duration of the race. For the avoidance of doubt, this does not apply to multiply parts of a single race in accordance with 12.7.

	Race 1	Race 2
	EUR	EUR
1 st place:	4,200.00	4,200.00
2 nd place:	3,600.00	3,600.00
3 rd place:	3,200.00	3,200.00
4 th place:	2,800.00	2,800.00
5 th place:	2,500.00	2,500.00
6 th place:	2.200.00	2.200.00
7 th place:	2,000.00	2,000.00

	Race 1	Race 2
	EUR	EUR
8 th place:	1,800.00	1,800.00
9 th place:	1,600.00	1,600.00
10 th place:	1,400.00	1,400.00

13.2.6 ProAm Classification

	Race 1	Race 2
	EUR	EUR
1 st place:	1,000.00	1,000.00
2 nd place:	800.00	800.00
3 rd place:	600.00	600.00
4 th place:	400.00	400.00
5 th place:	200.00	200.00

13.2.7 Team Championship

The awards for the end-of-year Team Championship will be as follows:

	EUR
1 st :	25,000.00
2 nd :	20,000.00
3 rd :	15,000.00
4 th :	10,000.00
5 th :	7,500.00

13.2.8 Rookie Classification

The end-of-year results of the "Rookie of the Year" classification will be awarded as follows:

	EUR
1 st :	12,000.00
2 nd :	8,000.00
3 rd :	4,000.00

For the avoidance of doubt, no other Competitor competing in a race other than permanent Competitors or Substitute Competitors are eligible to earn prize money. No Competitor from another series competing in the same race is eligible to earn prize money.

13.2.9 Trophies

The three overall winners as well as the first three drivers of the ProAm classification and a representative of the winning team of each race receive an adequate trophy during the podium ceremony after the race. The podium ceremony may be conducted either directly after the race on the podium or at a later point in time of the event at an alternative location.

Additionally, the first three drivers of the Rookie classification of each race receive an adequate trophy. These trophies may be handed over in a separate podium ceremony at an alternative location (.e.g. Porsche Hospitality).

Additionally, the first three Overall, ProAm, Rookie and Team Champions will receive trophies at the end of the year ceremony event. Accompanying the trophies, each Driver and representative of the winning team may receive a bottle of champagne during the podium ceremony. Both, the trophies and the champagne are included in the entry fee.

13.2.10 Prize for Fastest Race Laps

The Driver with the highest number of fastest laps from all races will receive a special reward item defined by Porsche Deutschland GmbH. In case of a tie Art. 8.1.9 applies.

13.2.11 Award Ceremonies

There will be at least two ceremony events with the goal to honor the winning Drivers and teams. One event during the last race weekend and one at the end of the year as festive season ending ceremony. Participation at these events is compulsory for all teams and Drivers. Admission for the following participants is included in the entry fee:

- Team Managers incl. companion
- Drivers incl. companion
- Additional: 2 passes per team

Participation in the ceremony events is mandatory for all drivers and team managers. In addition, it is mandatory for the winners of all Series awards to attend the end of season Porsche Carrera Cup Deutschland awards and the Porsche Night of Champions ceremonies. Any breach of these requirements will incur a financial penalty of at least EUR 2,500 which will be levied by the Series Organiser in respect of each individual award absentee unless explicit agreement has been given for their absence. Such agreement will only be given in exceptional circumstances. The Series Organiser reserves the right to cancel the event at his sole discretion. There is no entitlement to replacement or conversion.

13.2.12 Reigning Champion Support

In addition to the regular prize money, the Overall Winner of the Porsche Carrera Cup Deutschland 2023 (cf. 13.1) can apply for the Reigning Champion Support worth EUR 25,000.00. To qualify for an application, the driver must satisfy the following criteria:

- being the Overall Driver Champion of the Porsche Carrera Cup Deutschland 2023;
- being entered as a permanent entry to the Porsche Carrera Cup Deutschland 2024;
- being entered as a permanent entry to the Porsche Mobil 1 Supercup 2024;
- having competed in at least 75% of all races of the Porsche Mobil 1 Supercup 2024;

When satisfying the above criteria the Driver may apply for the Reigning Champion Support. The Driver who receives the Reigning Champion Support will be selected by the PMSC Series Organiser. The mere satisfaction of the above criteria does not entitle the driver to receive the Reigning Champion Support payment.

Only when the Driver is finally selected by the PMSC Series Organiser, the Driver will become eligible to receive the payment. The amount will be paid by the PCCD Series Organiser to the competitor (entrant) which signed the Driver for the Porsche Carrera Cup Deutschland 2024.

14 Protests and Appeals

The FIA International Sporting Code is applicable for protests and appeals, DMSB Event Regulations and the DMSB Legal System and Code of Procedure as well the FIA Legal System and Code of Procedure for FIA appeals.

Protest deposit – payable to DMSB:

- International / National status will be published in the Supplementary Regulations of the relevant event

Appeal deposit – payable to the DMSB:

- International status EUR 1,500.00
- Appeal to the FIA – payable to the FIA: EUR 6,000.00
(acc. to FIA Judicial and Disciplinary Rules)

The Series Organiser shall be entitled to be party to any appeal.

In accordance with Art. 15.1.4 of the FIA International Sporting Code, the Series is registered with the FIA by the DMSB which is the competent sporting tribunal for appeals.

In accordance with the FIA International Sporting Code Art. 12.3.4, appeals may not be made against any element of decisions resulting in the application of the following penalties applied by the Stewards or the Race Director:

- a) Drive through or Stop/Go penalties including those imposed during the last laps of a race or a time penalty (in lieu of a drive through penalty) after the race.
- b) Penalties stating or implying the cancellation of a number of practice or qualifying lap times.
- c) Penalties stating or implying a drop of grid positions for the race.
- d) Time penalties added to the whole race time during the race.
- e) Imposition of Reprimands or penalty points

Where the Stewards consider that they are able to make a decision regarding an incident whilst a race is still in progress and without the need for reference to images which they know may subsequently be available from any on-board camera, the availability of such images after the race will not be deemed to constitute the discovery of a significant and relevant new element in relation to any subsequent petition for review of that decision under Article 14 of the FIA International Sporting Code.

15 Choice of Law, Exclusion of Jurisdiction of a Court and Limitation of Liability

Subject to prevailing sporting regulations, these General Regulations for the Porsche Carrera Cup Deutschland shall be governed by the law of the Federal Republic of Germany.

The jurisdiction of a court is excluded for decisions of the FIA, the DMSB, their jurisdictions, the Stewards, the Series Organiser as judge in terms of § 661 German Civil Code.

No claim for compensation of whatever kind may be derived from actions and decisions of the DMSB or its jurisdiction as well as of DMSB representatives or the Series Organiser, except in the case of a damage caused on purpose or by gross negligence, except for damage or harm to life, body or health resulting from the deliberate or negligent breach of duty, including a legal representative or agents of the group of persons released from liability, and except for any other damage resulting from the deliberate or grossly negligent breach of duty, including a legal representative or agent of the group of persons released from liability.

Implied exclusions from liability shall remain unaffected by the above exclusion of liability clause.

16 TV Rights/Advertising and Television Rights

Copyright, all picture and sound rights as well as all television rights for the Porsche Carrera Cup Deutschland 2023 for both terrestrial broadcasting and cable and satellite television broadcasts, all video rights and all rights for exploitation by all electronic media are held by Porsche Deutschland GmbH. All manner of recording, broadcasting, repetition and reproduction for commercial purposes without the written permission of Porsche Deutschland GmbH shall be prohibited.

The Series Organiser is entitled to use exclusively all rights of the teams and their Drivers, particularly names, logos, team equipment and car, for the production of interactive games of the Series and to assign the rights to a third party for this purpose.

17 Specific Regulations

17.1 Paddock

- a) The image of the Series and the participating teams must be to a professional standard at all times. This includes, for example, team clothing, trucks, awnings, pit walls and antistatic floor coverings (explicitly no carpet flooring).
- b) Each team is required to provide an articulated truck with a working awning. It must be parked in the area designated by the Series Organizer. The standard size for the awning is defined as: 8m (width) x 13.5 m (length). The awning may contain an area at the rear specifically for team seating and relaxation.
- c) In exceptional cases, the Series Organiser reserves the right to permit the length of the awning to include the length of the tractor unit as well (extension). This needs to be applied for by the Competitor in written and must be approved by the Series Organiser.
- d) At least two competition cars must be accommodated in each working awning. Each Competitor will be permitted one truck and awning for a minimum of 2 and a maximum of 3 competing cars. It is mandatory to place and service all cars participating in the event at the team's awning in the PCCD paddock area.
- e) Prior to making any change to the on-site set up and working appearance a Competitor must submit a written (text form sufficient) request to, and receive approval from, the Series Organiser a minimum of 14 calendar days prior to the start of the competition concerned (ISC Art 2.1.7.a refers).
- f) Every Competitor must ensure that all safety-relevant aspects of its team's working processes are fulfilled and observed. Teams must also provide appropriate means of ensuring that awnings are secured robustly against weather/wind conditions and ensure these are maintained throughout each event. The entire on-site setup, e.g. awnings, trucks or any other temporary structures and their components, must fully comply with the applicable laws of the relevant event venue at the sole accountability of the Competitor.
- g) Should a Competitor have an exceptional need to bring an additional truck to an event, they must seek prior approval from the Series Organiser. Such approval will be subject to paddock space capacity, will be at the sole discretion of the Series Organiser and may be dependent on payment of an additional fee.
- h) Only the team trucks shall have access to the Series paddock. Small trucks and trailers shall only have access to the Series paddock for the purposes of loading and unloading during the official set-up and dismantling periods. Passenger cars, motorhomes and other vehicles are strictly forbidden and shall not have access to the Series

paddock at any time. The precise times for setting up and dismantling the paddock will be determined by the Series Organiser for each event. These times must be strictly adhered to. Violation of the setup- and dismantling times will result in a EUR 1,000 fine per case paid to the Series Organiser.

- i) All trucks must be washed before they are parked in the paddock. The location of the nearest truck wash will be announced by the Series Organiser prior to the respective event.
- j) The use of trucks and trailer roofs as well as lifting platforms as spectator platforms is prohibited.
- k) With the exception of Porsche Team Catering, all other kinds of catering are prohibited in the paddock of the Series. no separate hospitality or entertaining structures will be permitted by Competitors/Drivers within the paddock. During opening hours of the official hospitality no preparation or serving of meals is allowed in team awnings. Violation this rule will result in a EUR 1,000 fine per day paid to the Series Organiser.
- l) Teams may use their trailers, including the roof, for advertising, respecting at all times the requirements of Article 1.9 of the Technical Regulations. The Series Organiser retains the right, at its sole discretion, to instruct the removal of any advertising or branding that is deemed offensive or inappropriate or in the event that the Host-Event imposes any restrictions on such advertising.
- m) The Competitor is obliged to set up and dismantle any material provided by the Series Organiser to improve the paddock branding.

17.2 Instructions of the Series Organiser

Instructions of the Series Organiser and the paddock supervisors must be followed at all times.

In the event of failure of any team, team member, Driver, guest or other individual to comply with these regulations, the Series Organiser will notify the Stewards who may impose a penalty including a fine of at least EUR 500.00 and up to disqualification from the event.

17.3 Publication Obligation

The nationality of the issuing licence authority must be stated for publications and podium ceremonies.

17.4 Podium Ceremony

During the entire podium ceremony, except for the time during which the national anthems are being played, the Drivers on the podium must wear the caps of the tyre manufacturer on their heads with the logo to the front. The ceremony starts with ascending the podium and ends with leaving the podium after the group pictures for the press.

Any violation of this regulation will be penalised with a sports penalty of at least EUR 2,500.00 by the Stewards – the fine is payable to the ASN of the event. The payment of the penalty does not preclude any further penalty.

17.5 Stewards' Inquiries

The Stewards of the event may hold inquiries into incidents observed by them or referred to them by the Race Director, Technical Scrutineers, Series Organiser or other parties. The Stewards may seek evidence from any source they choose – in the case of incidents on track the Race Director shall present any video evidence available and at any time requested by the Stewards including during inquiries with Competitors and Drivers.

17.6 Incidents

- a) "Incident" means any occurrence or series of occurrences involving one or more Drivers, or any action by any Driver, which can be reported to the stewards by the Race Director (or directly noted by the stewards) which:
 - i. Necessitated the suspension of a session (red flag)
 - ii. Constituted a breach of these Sporting Regulations or the Code.
 - iii. Caused a false start in a race by one or more cars.
 - iv. Caused a collision.
 - v. Forced a Driver off the track.
 - vi. Illegitimately prevented a legitimate overtaking manoeuvre by a Driver.
 - vii. Illegitimately impeded another Driver during overtaking.
 - viii. Unless it was completely clear that a Driver was in breach of any of the above, any incidents involving more than one car will normally be investigated after the session.
- b) It shall be at the discretion of the stewards to decide, upon a report or a request by the Race Director, if a Driver or Drivers involved in an incident shall be penalised.
- c) If a Driver is involved in an incident, he must not leave the Circuit without the consent of the Stewards
- d) Each warning & reprimand which is issued by the Race Director or the Stewards will be noted in the reprimand list.

When a Driver has received 3 (three) warnings (b/w flag) or/and reprimands: drop of five (5) grid positions for the next race he will be participate.

When a Driver has received five (5) warnings (b/w flag) or/and reprimands: drop of ten (10) grid positions for the next race he will participate.

If a driver receives the defined number of reprimands in the last race, a drop of positions will be imposed on the final classification of the race.

After having received a drop of ten (10) grid positions, the reprimand count of the Driver will be reset to zero (0).

Warnings and reprimands expire at the end of the season.

17.7 Penalties

- a) At the individual events the Stewards and the Race Director of the event are responsible for imposing penalties to the participants, including Competitors, teams and Drivers. Penalties inflicted during practice, qualifying or Race will be displayed on the relevant information page of the official timing monitors and are thus considered to be notified.
- b) In addition to the cases listed in the International Sporting Code, these Regulations and the DMSB Regulations, the following circumstances or offences may also be punished by refusing permission to participate, or disqualify a participant from the event:
 - Non-compliance with the requirements for participation
 - Non-compliance with the Regulations in the code
 - Advertising for brands that compete with the Series sponsors
 - Unsporting behaviour

- Failure to comply with the instructions of the Series Organiser
 - Refusal to undergo a car check that has been ordered
- c) If any special examinations or investigations are required and ultimately lead to a penalty being applied by the Stewards of the event, then the costs of such examinations or investigations shall be met by the Competitor whose car is determined to be non-compliant and/or who is subject to such penalty.
- d) The fact that penalties have been imposed by the Stewards of the event does not rule out more extensive penalties, the relevant ASN or the FIA. These disciplinary bodies shall also be entitled to remove points won in races in the 2023 Series competitions.
- e) Should any competitor or driver have points removed, no other competitor's or driver's score shall be adjusted as a consequence.
- f) In the case of disqualification from a competition, the points gained and the prize money for the relevant race(s) shall be forfeited. In the event of disqualification from participating further in the Series, all points and prize money won up to that point shall be forfeited (no other competitor's or driver's points or prize money will be adjusted).
- g) The Stewards may impose any penalty they consider appropriate for a breach of the regulations, up to disqualification from the competition. The Stewards may also decide to impose a suspension for one or more competitions of the Series. Ocontains a set of guideline penalties that will be taken into consideration by the Stewards, but each case will be considered on its own merits.

17.8 The Track

Drivers must use the track at all times and may not leave the track without a justifiable reason. For the avoidance of doubt:

- The white lines defining the edge of the track are considered to be part of the track.
- A Driver will be judged to have left the track if all four wheels of the car go beyond the white line.
- Any kerbs installed beyond the white lines are not considered to be part of the track.
- Any report made by a duly appointed Judge of Fact regarding a Driver having left the track may not be contested by the Competitor or the Driver concerned and a Judge's statement of fact must be accepted as a fact unless later corrected by him or over-ruled by the Stewards. The Race Director and/or the Stewards may, at their sole discretion, review any report for the purposes of ensuring accuracy and consistency. This does not preclude the Stewards from exercising their right to over-rule, or accept a correction from, a Judge of Fact.

The following penalties may be applied.

17.8.1 Practice

Any Driver identified by a judge of fact as having left the track (unless for reasons beyond his control) may have that lap time (and where appropriate the following lap time) deleted by the Race Director or the Stewards.

Any Driver who repeatedly leaves the track may receive a penalty, the minimum being a Stop/Go penalty of three (3) minutes. If the penalty cannot be fully served within the current session it must be served in the following qualifying session.

17.8.2 Qualifying

Any Driver identified by a judge of fact as having left the track (unless for reasons beyond his control) may have that lap time (and where appropriate the following lap time) deleted by the Race Director or Stewards. Any Driver who repeatedly leaves the track may receive a penalty up to and including a deletion of all lap times or a drop of grid positions for the race. It is not a condition that the Driver must have been shown the Black and White flag before a penalty is applied.

17.8.3 Race

Any Driver identified by a judge of fact as having left the track (unless for reasons beyond his control) on a number of occasions will be shown the black & white flag as a warning.

Any Driver who continues to leave the track may receive a penalty, the minimum being a race time penalty of five seconds. Further offences may result in further penalties. It is not a condition that the driver must have been shown the Black and White flag or received a radio warning from the Race Director before a penalty is applied. At the absolute discretion of the Race Director, a driver may be given the opportunity to give back the whole of any advantage he gained by leaving the track.

17.9 Effectiveness of the Regulations and Ranking

In the event of a conflict between the entry documents and these regulations, then the current version of these regulations shall take precedence.

17.10 Environmental Regulations

17.10.1 General

It is the Competitor's responsibility to ensure that at all times during the event that the environmental code of conduct of the DMSB and the circuit is followed.

17.10.2 Tyre Cleaning

Tyre cleaning by water shall only be performed by the series appointed tyre service with a closed-circuit water disposal system. Individual tyre cleaning by water is only allowed if all wastewater is collected and disposed of in the designated area(s). Any and all exceptions require the permission of the Series Organiser.

17.10.3 Collection of Hazardous Liquids

It is the Competitor's responsibility to ensure at all times during the event that hazardous liquids are collected by containers or absorbing sheets and disposed in the designated area(s). It is recommended to cover the complete working area below the cars in the tent with absorbing sheets. Any hazardous liquid container needs to be stored in a separate container that holds any spillage or overflow.

18 Safety

18.1 Extrication Exercise

At each event, the Series Organiser, in conjunction with the event medical personnel, may elect to hold an extrication

exercise. The Series Organiser shall, by rotation, nominate a team and Driver to take part in the exercise. The team and Driver must comply with this request and have the nominated car and Driver, with all racing equipment, available at the designated date and time in the Series paddock, in full race condition.

18.2 Pit Lane Safety

- a) The maximum speed in the pit lane during practice, qualifying and each race is specified by the promoter in the Supplementary Event Regulations and monitored by the Race Director and the Stewards. Drivers exceeding the permitted maximum speed during free practice and in qualifying sessions shall be fined EUR 200.00 plus EUR 25.00 for each km/h over the specified limit. The penalty is to be paid to the national ASN. Drivers who repeatedly exceed the permitted maximum speed in the pit lane during free practice and qualifying may face additional penalties for speed limit violation. Drive through penalties may be issued if the permitted maximum speed in the pit lane is exceeded during a race. During the last laps of a race where a drive through penalty cannot be served, a post-race time penalty of 30 seconds may be imposed, in lieu of the drive through penalty.
- b) The use of safety stands (securing the car from dropping unintentionally from the air jacks) for any type of work underneath the car is strictly enforced. Any non-compliance will be reported to the stewards and penalized at the full discretion of the Stewards.
- c) All work on cars in the pit lane must only be undertaken in the inner (working) lane. No work may be undertaken in the outer (fast) lane. When cars are waiting in the outer (fast) lane prior to exiting the pit lane at the start or restart of any practice or qualifying session or race, no work of any description may be undertaken on the car. It is permitted to use a forced air blower to cool the Driver, but any such cooling equipment must be removed from the outer (fast) lane before the pit lane open signal is given.
- d) The outer (fast) lane is to be kept unobstructed to allow safe passage of cars at all times. It is the responsibility of each Competitor to release their car from the working area only when it is safe to do so. Cars in the fast lane have priority over those leaving the working lane.
- e) Unless instructed otherwise by the Race Director, during all practice and qualifying sessions cars must be parked at an angle of 45 degrees, nose in towards pit garages, whenever they are stopped in the team's pit area. When a car is ready to leave its pit area, the car must be pushed backwards (not reversed under its own power) with a team member responsible for ensuring the car is released safely and without impeding other cars.
- f) The responsibility shall be on all Drivers to take due care and drive within the pit lane speed limit. Drivers must respect the designated pit entry and must not cross the white line neither at the pit entry nor at pit exit, details of which will be provided in the Drivers' Briefing.
- g) All equipment must be kept in a safe position towards garages as soon as cars leave their pit areas at the start of and during practice, qualifying and race.
- h) No equipment may be positioned on top of the pit wall or any adjacent structure unless it is firmly secured in position.
- i) Competitors, team members and Drivers are responsible for the conduct and safety of their guests in the pit lane area. Guests must carry the correct credentials at all times. Any guest found in the pit lane without the correct pass

will be excluded from the pit lane and the Competitor will be reported to the Stewards. No person under the age of 16 is permitted in the pit lane at any time.

- j) Competitors, team members and Drivers must ensure that their guests always respect the pit lane regulations and be vigilant at all times. To this end, it is the responsibility of each Competitor and/or Driver to give a briefing to each individual guest regarding pit lane safety.
- k) Competitors, team members and guests must wear closed footwear in the pit lane at all times, open footwear is not permitted. It is strongly advised that long trousers (not shorts) are worn by team members. Competitors are responsible for informing their guests of suitable clothing standards when in the pit lane, including footwear and a recommendation for long trousers (ladies and gentlemen) together with covered shoulders.

18.3 General Safety

- a) Drivers are strictly forbidden to drive their cars in the opposite direction to the specified direction unless this is necessary in order to move the car from a dangerous position. A car may only be pushed to remove it from a dangerous position as directed by the marshals. No car may be reversed in the pit lane under its own power.
- b) At any time whilst on track, Drivers may only use the track and must at all times observe the provisions of the International Sporting Code and these regulations relating to driving behaviour on circuits.
- c) Official instructions will be given to Drivers by means of the signals set out in Appendix H of the FIA International Sporting Code. Competitors are responsible for observing and complying with these at all times. At circuits where flag signals are supplemented by light panels/signals, both means of signalling will be deemed to have regulatory value.
- d) If a car stops during practice or a race it must be removed from the track as quickly as possible so that its presence does not constitute a danger or hinder other Competitors. If the Driver is unable to drive the car from a dangerous position, it shall be the duty of the marshals to help; however, if any mechanical assistance is required to move the car then the car will not be permitted to re-join. A Driver who abandons a car must leave the steering wheel with the car.
- e) The car lights must be illuminated at all times (light switch in position ON) when it is running on treaded tyres and/or on a track that has been declared wet and/or the "lights on" board has been shown. The technical scrutineers may check the lights at any time until 15 minutes before the green flag. No penalty will be imposed if the lights fail during

a race, nor need the car be stopped. no penalty will be imposed but the Race Director may stop a car using the black and orange flag if he considers this is causing an immediate safety issue.

- f) If a Driver is involved in an incident, he must not leave the circuit without the consent of the Stewards.
- g) Throughout all sessions there will be a green/red light at the pit exit. Cars may only leave the pit lane when the green light is on.
- h) Any Driver intending to leave the track or to go to his pit or the paddock area must signal his intention to do so in good time making sure that he can do this without danger.
- i) In the Drivers Briefing, the Race Director may define a time and place for practice starts. It is forbidden to undertake a practice start at any other time or place.
- j) At the end of any session or race, each Driver may cross the Control (Timing) Line only once.
- k) Team personnel are not permitted to ride on the tyre trolleys or on buggies (or the like) apart from using the specific seats provided with the vehicle.
- l) Only small two- and four-wheeled motorised paddock vehicles may be used within the paddock and must be authorised by the Series Organiser prior to use. These vehicles may only be used when driven by a current full road traffic licence holder for race team related business. Recreational use is strictly prohibited. Private cars and vans are not considered as paddock vehicles.
- m) The speed limit in the paddock at each venue is 10 kph.
- n) Tailgates on transporters must remain closed at all times except when loading and/or unloading at the beginning and end of each event.
- o) The workshop awnings used on site must ensure a safe working environment. The awnings shall represent the professional standard of the Series and must be approved by the Series Organiser.
- p) So called easy-up-tents, i.e. tents which do not meet the criteria for temporary structures in Germany, are only permitted as additions to the main workshop awning. The number of easy-up tents is limited to 1 tent (8 x 4 m) per team. The use of sufficient ballast weights and safety measures are obligatory. Only bespoke awnings attached to the team's truck or structures which are certified to the standards of temporary structures in Germany may be used as workshops during the events. Non-compliance will result in a fine of EUR 2,000.00 for each car, which is housed in a non-approved structure. The fine must be paid to the Series Organiser.

Part 2: Technical Regulations

1 Technical Series Regulations

1.1 Summary of the eligible groups/classes

The Porsche Carrera Cup Deutschland is a one-make Series with no group/class classification.

Only technically identical cars of the model Porsche 911 GT3 Cup, type 992 (a special series produced by Porsche AG), of the model year 2021, 2022, 2023 and which fully comply with these Regulations are eligible to participate.

The cars must meet the technical specifications of these regulations and Appendix J of the International Sporting Code in full and must possess a valid and registered DMSB car pass or the corresponding document of another ASN associated to the FIA.

Cars may only deviate from the Technical Regulations where specifically agreed for development purposes on behalf of the Series Organiser. The deviations shall be referred for approval to the Scrutineers by the Series Organiser before the car is used and shall not involve any safety-critical modifications nor may they provide any performance or competitive advantage. Where required by the Series Organiser, Competitors must comply with the fitting of any additional parts or systems for development purposes.

1.2 Principles of the Technical Regulations

In accordance with:

- Art. 251 and 277 (Group EII-SH) of Appendix J (FIA ISC)
- General provisions, definitions and clarifications regarding the technical rules (DMSB Manual, blue part), see also Art. 1.10 concerning safety equipment in events abroad
- These Technical Regulations
- Technical Manuals of the eligible cars
- Technical Information of Porsche AG
- Software Information of Porsche AG
- Spare Parts Catalogues of the eligible cars

Competitors must comply with all elements of each of the above unless they are clearly specified as being optional.

National regulations of the DMSB deviating from the FIA safety regulations are not valid for series and events with the status international. The safety regulations according to Art. 1.10 of these regulations apply.

Should there be any discrepancy between the provisions of these Technical Regulations and any relevant Technical Manual, Technical Information, Software Information or Parts Catalogue, then these Technical Regulations will take precedence.

Any requirements specified in a Technical Manual, Technical Information, Software Information and/or Parts Catalogue may be updated by Porsche AG. For Software Information, only the latest version is valid, but Setups (based on the latest version) may be varied within the parameters allowed by Porsche AG.

It is recognised that spare parts listed in the parts catalogue may be subject to a change of part number during the season. Therefore, a spare part which is identical to that shown in the parts catalogue (and which has the same function, working principle and location in the vehicle) but which bears a different part number may be used, subject to

prior approval by Dr. Ing. h.c. F. Porsche AG Motorsport Aftersales Department. Such approval shall be at the sole discretion of Dr. Ing. h.c. F. Porsche AG and it is the responsibility of the Competitor to ensure such approval, where granted, is documented and retained for inspection by the Technical Scrutineers.

Certain alternative parts as detailed in Attachment 9 which have different part numbers to, but the same function as, the original part in the car or in the spare parts catalogue are allowed to be used for the originally intended function and in the originally intended position.

1.3 General/preamble

Everything that is not expressly permitted in these regulations is prohibited.

Any addition or removal of material, heat treatment or coating to alter the properties of a part or component and/or its dimensions is forbidden. Mounting a part in a different way or location than the original delivery condition is forbidden. Permitted modifications must not result in any illegal modifications or infringements of the regulations. Any permitted changes may only serve the intended purpose. The decision of the Sporting Committee shall be final regarding any interpretation of these Regulations. The Series Organiser reserves the right to amend and extend these regulations (in consultation with the DMSB).

The installation of any permitted optional parts or systems must be in accordance with the manufacturer's instructions and must be approved by the Technical Scrutineers. Any such installations remain the sole responsibility of the participant. At the Technical Scrutineers discretion, any Competitor must, if requested, remove any optional part or system."

1.4 Driver equipment

Driver equipment must be worn at all times whilst the Driver is seated in the car in the pre-grid area, the pit lane and on the track. It is compulsory to wear overalls in compliance with the FIA standard 8856-2000 or 8856-2018 standard as well as underwear (with long sleeves and legs), balaclava, socks, shoes and gloves in compliance with FIA Regulations.

Furthermore, wearing a helmet in compliance with FIA Regulations ISC Appendix L is compulsory.

All Driver equipment must be worn in accordance with the manufacturer's instructions (balaclavas inside race suits, FHR systems correctly secured, etc). Failure to do so may result in the Driver being shown the black flag and/or being ordered by the Race Director or the Stewards to immediately rectify any error or omission.

1.4.1 Frontal Head Restraint System (FHR; HANS® or comparable system)

The use of an FIA-approved head restraint in compliance with FIA list No. 29 is compulsory for all races and events within the championship as well as for all races outside the championship which are organised according to these regulations.

Responsibility for the necessary modifications to the Driver's equipment in order to enable use of such a system and installation of same in the car in compliance with the manufacturer's instructions lies solely with the participant. The relevant manufacturer's certificate is to be presented during Technical Scrutineering.

1.4.2 Drinking system

Only the following drinking system is permitted to be used:

- MTH860003AE - drinking system basic set MTH

- MTH000025A - wiring kit 992 cup

It must be installed according to the latest installation manual provided by Manthey-Racing. The installation needs to be approved by the scrutineers prior the event.

1.4.3 Cooling system

A cooling system with cooling vest may be used. Installation needs to be fixed using metal hardware on the auxiliary weight base plate and be able withstand a crash of 30G.

Prior to installation it has to be approved by the Technical Scrutineers. The installation according to the manufacturer's instructions is the sole responsibility of the participant.

1.5 General Regulations

Permitted modifications and installations

The only work which is permitted to be carried out on the cars is the work necessary for its normal servicing, or for the replacement of parts worn through use or accident.

The limits of the modifications and installations permitted are specified hereinafter. Any part worn through use or accident may only be replaced by identical Porsche Genuine Parts that are assigned to the eligible cars in compliance with Item 2.1. The Porsche Genuine Parts are specified in the valid spare parts catalogue in each case.

The use of components manufactured by Porsche AG for other groups of cars (e.g. Porsche road cars) is also prohibited.

The use of any items described as "optional" in the parts catalogue is prohibited, as long as their use is not in particular permitted by these technical regulations.

Throughout the car, the standard fastening components such as nuts, bolts, washers, lock washers, spring washers and splint pins must only be replaced by Porsche Genuine Parts.

The service and replacement intervals and adjustment values specified by Porsche AG (see Technical Manual) are to be observed.

The Series Organiser may allow modifications that do not correspond to the series production status on all or individual cars, providing these do not permit a competitive advantage (e.g. for the attachment of cameras; radio installations, etc.). The Competitor must make written application to the Series Organiser and receive written authorisation before making any such modification.

1.6 Minimum weights and ballast

It is the Competitor's responsibility to ensure that at all times during the event the mandatory minimum combined weight of the car with empty fuel tank, Driver equalisation weight and the Driver (together with all Driver equipment) is reached. At no time during an event is the car weight permitted to be less than the mandatory minimum weight.

The mandatory combined minimum car and Driver weight (together with all Driver equipment and equalisation weight) will be announced by Stewards Bulletin at the end of Technical Scrutineering of the first event.

The minimum car weight must also be observed when the levels of operating liquids are under minimum level.

The checking of the weights of the cars and Drivers will be conducted on the "official scale" which will be located in the Series Technical Scrutineering tent or in an alternative designated place. This is also the weighing area. In

addition, Drivers may be weighed on a separate weighing scale either in the weighing area or in an alternative location (e.g. the pit lane). Any scale specified by the Technical Scrutineers will be deemed "official scale(s)".

All "officials scale(s)" will be checked annually and calibrated by either the certificated Porsche Testing Laboratory or any other officially certificated Testing Laboratory.

1.6.1 Ballast

The installation of original Porsche ballast weights is permitted on the auxiliary weight base plate at the position of the passenger's seat in accordance with the illustration in Attachment 3. The ballast weights are identified by spare part numbers in the spare parts catalogue and the reference table in Attachment 9. No other ballast weights or locations are permitted.

1.6.2 Minimum car weight

The minimum weight of a car will be announced by Stewards Bulletin at the end of Technical Scrutineering of the first event. The minimum weight of a car consists of:

- the weight of the car with empty fuel tank;
- the weight of the onboard camera (surveillance camera and the official TV camera), the radio system assigned by the Series Organiser or the weight of the respective Substitute ballast;
- the installed additional weights (excluding Driver equalisation weight);
- equipment for Driver's cooling vests installed to the base plate auxiliary weight;
- the weight of any additional parts or systems required by the Series Organiser to be fitted for development purposes in accordance with Article 1.1.

When the standard exhaust system is used, the minimum weight of a car is tba (cf. 2.2.3).

1.6.3 Minimum Driver weight

The minimum Driver weight will be announced by Stewards Bulletin at the end of Technical Scrutineering of the first event. The minimum Driver weight consists of:

- the Driver;
- the personal equipment of the Driver as it is in the car at the time when the weighing is ordered;
- the Driver equalisation weight if applicable.

It is the Driver's responsibility to ensure that the sum of the installed equalisation weight plus his/her actual weight (including the parts of his/her personal equipment in the car at the time of the order to weigh the car) is reached at all times.

1.6.4 Determining the total weight of the Driver and car

The Technical Scrutineers may in their absolute discretion decide to weigh the car and Driver separately or in combination.

If the car and the Driver (together with all Driver equipment) are weighed in combination, the weight plus 2.0 kg of weighing tolerance shall be added and the product shall be referenced against the mandatory minimum combined weight, which must be reached.

If the car and the Driver (together with all Driver equipment) are weighed separately on the official scale, the two

weights plus 2.0 kg of weighing tolerance for the car and 0.5 kg of weighing tolerance for the Driver weight shall be added and the product shall be referenced against the mandatory minimum combined weight, which must be reached. Prior to weighing a car, the Technical Scrutineers shall remove the remaining fuel from the fuel tank, after taking a fuel sample.

1.6.5 Weight changes during qualifying and race

During the qualifying and race, the weight of the car is only permitted to be altered by:

- Changing from slick tyres to wet tyres or vice versa;
- Consumption of consumable materials and fluids.

On the way from the circuit to the Parc Fermé and in the Parc Fermé itself, and on the way to the post-race Technical Scrutineering under no circumstances is weight permitted to be added to the car or the Driver.

1.6.6 Verification of the minimum weights by the participants on the official scale

Competitors have the opportunity to check the weight of their cars and Drivers during the event on the official scale with the permission of the Technical Scrutineers. Only the measurements recorded by the Technical Scrutineers shall be deemed accurate for the purposes of compliance with the regulations.

1.6.7 Personal protective Driver equipment during weighing

During the weighing, each Driver must wear his/her complete Driver apparel as set out in Annex L, Chapter III of the ISC, plus the mandatory head restraint system.

1.6.8 Weighing of cars

Weighing of cars is carried out regularly on the official scale.

During the free practice and qualifying, weighing can also be done by the Technical Scrutineers on the scale of DMSB, which is at a fixed location in the pit lane. Any differences between these scales are taken into account by the Technical Scrutineers. If the weighing on the DMSB scale indicates that the car in question might be found underweight on the official scale, this car, the Driver and his/her protective equipment must again be weighed on the official scale which is the only result to be taken into consideration and to be binding.

If a Driver is given the signal that his/her car has been selected for weighing, he/she must take the shortest route possible to the weighing area/DMSB scale and turn off the engine.

The Driver or a team member will receive notification of the measured weights. During weighing the Driver is not permitted in any way to influence the weighing result.

Any appeal against the observed weight must be immediately submitted to the Technical Scrutineers after receiving the report.

If a car cannot reach the weighing area under its own power, it must be brought to the weighing area solely by marshals. If this is not possible, then the Technical Scrutineers can assign other persons for this purpose.

1.6.9 Leaving the weighing area

Without the consent of the Technical Scrutineers, the Driver is not permitted to leave the weighing area and the car is not permitted to be removed.

1.6.10 Weighing after breakdown and car remaining on circuit during qualifying and race

If a car breaks down during the free practice, qualifying or the race and the Driver leaves his/her car, he/she must go directly to the weighing area to determine his/her weight.

1.6.11 Determining the Driver weights

After every free practice, qualifying and race, all Drivers must go immediately and within 20 minutes of the end of the session (unless amended in the Drivers' Briefing notes) on a direct route from the Paddock/Parc Fermé to the weighing area to determine their weight (together with all Driver equipment). Drivers who are approached by the TV partner for an interview may interrupt their walk to the weighing area for the duration of the interview. Drivers who go to the podium are permitted to be weighed on the DMSB scale. Any differences between the DMSB scale and the official scale are taken into account. Drivers who do not go directly to the weighing area to be weighed will be reported to the Stewards. The Stewards will take the final decision regarding a penalty.

The Drivers will be weighed individually. Once the Driver leaves the weighing area, this will be deemed implicit acceptance of the recorded weight. Any appeal against the observed weight must be immediately submitted to the Technical Scrutineers.

1.6.12 Replacement and loss of car parts

All car parts that were replaced during the free practice, qualifying session and race must be presented to the Technical Scrutineers without request for inspection. The parts that were removed from the car will be marked by the Technical Scrutineers if necessary and are not permitted to be modified in any way afterwards. These parts must remain in the pit or in the technical scrutineering tent in sight of the Technical Scrutineers or their assistants until released by the Technical Scrutineers. These parts can be considered when determining the weight instead of the replaced parts.

In case of a loss of coolant, caused by damage or an incident during the session, it is possible to determine the final weight of the car by draining all remaining coolant liquid (from engine, coolant reservoir, all radiators, all coolant hoses and connectors) and adding 24.0 kg to the measured weight of the car. The decision to do so lies in the discretion of the scrutineers.

Should a car be presented for weighing with lost or damaged parts it shall be at the sole discretion of the Technical Scrutineers to determine which, if any, parts should be replaced prior to the car being weighed.

1.6.13 Parc Fermé rules for car weighing

Cars that have been specified for weighing are subject to Parc Fermé Regulations. It is forbidden to add or remove any substance to/from the car after it has been selected to be weighed. The same applies during the weighing process and after the end of the race. Excluded are actions of the Technical Scrutineers.

It is the Competitor's responsibility to ensure that the car entered by him can be brought directly to the weighing area when instructed by the Stewards or the Technical Scrutineers at any time during the event. In any case, Parc Fermé rules apply to the car from the moment of the order until the termination of the weighing process.

1.6.14 Weighing in below the minimum weight

If, during any post session weighing procedure, the combination of the separate weights taken of the car and Driver (including Driver equipment) is found to be below the currently applicable combined minimum weight, the car will immediately be weighed for a second and a third time on the same scales and in the same condition after the same

session and with the same measuring method.

The maximum value of the 3 car weights recorded is regarded as the actual car weight. The Driver weight shall be added to form the combined of the combination of car and Driver (including Driver equipment).

Falling below the minimum weight during the qualifying session will be penalised with the cancellation of the qualification times achieved by the Driver concerned. The Driver is permitted, however, to take up the race from the last place on the starting grid.

Falling below the minimum weight in the race will result in disqualification from the points and race result for the race.

1.6.15 Regulations on the route to and in the weighing area

Moreover, Parc Fermé rules apply to the route to the weighing area and in the weighing area itself. Only the responsible sporting marshals and their helpers are permitted to enter the weighing area. In this area, the only activities on the car are those expressly permitted by the aforementioned persons. If a car is not presented for weighing despite a request, the Technical Scrutineers will inform the Stewards.

1.7 Emissions regulations

The cars must be equipped with a catalytic converter as supplied by Dr. Ing. h.c. F. Porsche AG and in accordance with the DMSB exhaust gas emissions regulations.

1.8 Noise regulations

The maximum permitted noise limits are 144 dB (A) measured in compliance with the L_{WA} - procedure and 112 dB (A) in compliance with L_P -procedure.

The noise level will be determined in compliance with the DMSB-pass-by measuring method (mandatory for all circuit events).

The current DMSB-noise regulations (see DMSB Manual, blue part) must be respected.

1.9 Advertising and partnerships

The current FIA/DMSB prescriptions for competition number and for advertising on the Driver's equipment/on the race car and start numbers (see DMSB Manual, blue part) must be respected.

Under consideration of the FIA/DMSB prescriptions for competition numbers and advertising on cars, the following advertising is compulsory on the race car (cf. Attachment 2):

1.9.1 Series Advertising and Competition Numbers

- a) The advertising decals, logos, Driver name and competition numbers as specified by the Series Organiser, must be affixed to all competing cars during the free practice, qualifying sessions and races of the Series. The size, type, quantity and positioning are determined and announced in the "2023 Sticker Regulations". The Sticker Regulations are agreed on with the DMSB.

The "2023 Sticker Regulations" are part of these Regulations (see Attachment 2). Any breach of these Regulations will result in an automatic financial fine paid to the Series Organiser. The amount of the automatic fine is calculated as follows:

First-time violation:	EUR 1,000.00 per violation.
Second-time violation:	EUR 2,000.00 per violation.
Third-time violation:	EUR 5,000.00 per violation.

Furthermore, the stewards may impose a penalty either in addition of or as a replacement to the financial fine. Contravention can lead to refusal to participate in any competition or disqualification from the competition, in each case at the discretion of the Stewards.

- b) All advertising surfaces that are not occupied as specified in the Sticker Regulations are available for the Competitors' own advertising labels. The clearance between such advertising and the mandatory labels and competition number shall be a minimum of 30 mm.
- c) Cars of a team with virtually identical liveries must have clearly different wing mirror colouring and rear wing lateral end plate. The colours of the afore mentioned mirror and rear wing colours used to identify the cars are to be retained for the entire season.

Any regulation on Driver's equipment and on-car advertising is mandatory starting with the beginning of the pre-season test. Due to official media production cars and drivers' equipment must match the illustrations displayed in Attachment 1 and Attachment 2 of Part 3 of these regulations.

The Drivers' names and competition numbers must be fixed on all competing cars throughout the entire event. The size, type, quantity and positioning of the identifications shall be determined by the Series Organiser and notification is given in the "2023 Sticker Regulation" (Attachment 2).

The Competitor is responsible for ensuring that the stickers on the entered cars comply with the applicable legal regulations.

IMPORTANT: Any variations of the FIA/DMSB Regulations are subject to a special waiver issued by the DMSB.

1.9.2 Partnerships

- a) Competitors must not enter into partnerships/sponsorships with or advertise for any companies who are either in competition to Dr. Ing. h.c. F. Porsche AG, its parent or partner companies, the official Series partners of Dr. Ing. h.c. F. Porsche AG or who are involved in a legal dispute with Dr. Ing. h.c. F. Porsche AG or a company associated with Dr. Ing. h.c. F. Porsche AG.

The Competitors are therefore obliged to notify potential partnerships to Dr. Ing. h.c. F. Porsche AG in advance. Dr. Ing. h.c. F. Porsche AG is entitled to prohibit teams from entering into a partnership if the potential partner falls into one of the above two categories.

- b) The use of advertisements for companies, their products, services or brands that are Competitor products, services or brands of Dr. Ing. h.c. F. Porsche AG, their associated companies or the Series partners/sponsors on cars, helmets, race suits and other Driver equipment, on team vehicles or on team clothing or any other kind of advertising for these companies, products or services is strictly prohibited.
- c) The use of advertisements for companies in the tobacco and sex industry, or political or religious advertising, or private betting and gambling operators on cars, helmets, race suits and other Driver equipment, on team vehicles or on team clothing or any kind of advertising for these companies, products or services or anything that may be deemed by Dr. Ing. h.c. F. Porsche AG to bring the company and/or the Series into disrepute is strictly prohibited.
Private betting and gambling operators may be exempt from this prohibition if they possess a valid permit from the responsible authority. The permit has to be presented to the Series Organiser in writing. The Series Organiser reserves the right to refuse the exemption.
- d) The advertising guidelines of the FIA and DMSB as well as general or legally regulated advertising bans must be observed.
- e) The Competitor is obliged to notify the Series Organiser of all potential partners/sponsors and obtain written approval and obtain written approval from the Series Organiser to their use. The Series Organiser is entitled to prohibit teams from displaying or promoting in any manner the details of any unapproved partners/sponsors.
- f) Competitors may only use the spaces given by their working equipment (truck, awning etc.) to advertise for their partners and sponsors. Furthermore, it is prohibited to setup or use any kind of advertising space (physical/digital) to display advertisements for a company or a product which has no other contractual relationship to the competitor than the display of this very advertisement. Competitors may setup additional equipment (e.g. beach flags, stands for autograph cards etc.) only to promote their team and drivers.

Contravention of any of the advertising regulations may result in a fine of at least EUR 1,000.00 and/or refusal to participate in any event or exclusion from the event, in each case at the discretion of the Stewards of the event.

1.10 Safety equipment

The cars must possess the following safety equipment.

The Art. numbers refer to the current Appendix J of the ISC unless stated otherwise:

Art. 277 (Group EII–SH)

For events abroad, the Series Organiser is responsible for observing and implementing deviating or additional safety regulations of the respective ASN.

The on-board fire extinguisher system must be switched into position "Armed" and the red LED illuminated from the moment a car leaves its team area to travel to the pre-start area for each session and must not be switched off until the car is returned to the team area after the session.

1.11 Fuel type and single fuel

1.11.1 The following single fuel must be used:

The only permitted fuel is unleaded fuel in compliance with Art. 252.9 of the Appendix J (ISC) which must comply with DIN EN 228 and must be from a supplier specified by the Series Organiser. A new supplier can be designated for each event (fuel pumps, tanker, or similar). Only the specified fuel is permitted to be used for the duration of the event.

1.11.2 Fuel controls

The Technical Scrutineers shall be entitled to take fuel from a participant's car at any time during the event. At any time of the event until the end of the protest deadline (subject to removal of fuel for the weighing procedure), the Competitor must ensure that a minimum of 2.0 kg of fuel can be taken from the corresponding removal point (fuel removal valve) in the luggage compartment. These samples must be identical to the reference fuel taken from the fuel supplier designated above. If the Technical Scrutineers order to defuel the car (for example to check the minimum weight of the car without residual fuel), a fuel sample-must be taken prior to defueling the car.

The defueling process will be done on the measuring platform of the Technical Scrutineering area. If necessary, the Technical Scrutineers may specify a different location. During defueling the vehicle must stand on the platform (or the ground if a different location has been specified) on all four wheels and must not be moved. The required quantity of fuel must be extracted from the removal point defined above within a maximum of 10 minutes after the start of defueling.

1.11.3 Refuelling, Refuelling installations and control

The addition of any additives or any chemical change to the fuel is prohibited.

Fuelling and refuelling of the cars during free practice, qualifying and the race is forbidden. All chemical changes to the fuel are forbidden.

Throughout the event the temperature profile of the outdoor air temperature will be recorded by the Technical Scrutineers with the use of a special temperature recorder defined by the Series Organiser. The minimum value of the last 24 hours will be posted on the Series notice board before the first session of each day. At no time is the fuel temperature permitted to be less than the lowest outdoor air temperature as posted on the notice board.

Any operations involving the handling of fuel require the proper grounding to earth of the car and all equipment involved; in addition, there must be two 9 kg ABC Dry Powder or alternatively two 5 kg CO2 fire extinguishers present in the area of the fuel operations. Fuel may only be added or removed into or from the fuel cell of the car using a closed-circuit fuelling system manufactured by a specialist company (the Series Organiser reserves the right to inspect any system being used and approve or disapprove its use). The exact specification of the closed-circuit fuelling system may be chosen by the team according to their needs (size, pump speed, etc.) however no safety aspect of the system is permitted to be changed.

Should there be any circumstances where a Competitor is unable to use the closed-circuit fuelling system, then any fuel operations must be performed outside the team tent in a fenced and gated area of at least 5m in each direction of the car. All personnel working in this area must wear full fireproof clothing (including shoes, gloves, goggles, balaclavas, etc.). The car and all equipment must be grounded to earth properly and at least two 9 kg ABC Dry Powder or alternatively two 5 kg CO2 fire extinguishers with stand-by personnel (not involved in any fuel operations) must be present in this area. Under no circumstances must members of the public, Competitors, team guests or unauthorised personnel be permitted in this area at any time during the fuelling operation; it is the responsibility of the team to ensure that such persons are excluded from the area.

Any work requiring the fuel cell to be opened may only be performed after all fuel has been completely removed from inside the fuel cell and with appropriate protection and fire extinguishers being present at the respective workplace.

Smoking and hot works are prohibited when any operation involving fuel or the fuel cell is in progress.

1.12 Technical Definitions

In addition to the definitions in the "General Regulations, Definitions and Clarifications regarding the Technical Regulations" (DMSB Manual, blue part) the definitions set out in Appendix J (Art. 251 ISC of the FIA) shall apply.

1.13 Car Change

A change of cars must be applied for in writing by the Competitor and must be approved in written form by the Series Organiser prior to the change. The decision to approve a change of car is at the absolute discretion of the Series Organiser.

Drivers whose car changed during an event must in all cases start the next race behind the other Drivers from the end of the starting grid. Should more than one Driver have his/her car changed, their starting positions at the back of the grid will be determined by the time they requested the change in written. In any case the Series Organiser has to forward a copy of the approval to the stewards, who will decide to amend the starting grid.

Cars may only deviate from the Technical Regulations where specifically agreed for development purposes on behalf of the Series Organiser. The deviations shall be referred for approval to the DMSB by the Series Organiser before the cars is used and shall not involve any safety-critical modifications nor may they provide any performance or competitive advantage. Where required by the Series Organiser, Competitors must comply with the fitting of any additional parts or systems for development purposes.

2 Specific Technical Regulations

2.1 General Information

General car description

Porsche 911 GT3 Cup (992), MY 2021, 2022, 2023

Concept: Single-seated, near-standard car based on the Porsche 911 GT3.

For further general descriptions, the Competitor (entrant) shall refer to the respective paragraph of these technical regulations.

Important Information

Certain special parts used in the Porsche 911 GT3 Cup cannot be obtained via the Porsche dealer organisation but instead can only be obtained from the Motorsport Parts Sales Department at Dr. Ing. h.c. F. Porsche AG.

Dr. Ing. h.c. F. Porsche AG
Abteilung Sportteileverkauf/EMV4
Lüssenweg 16
71701 Schwieberdingen
Germany
Tel.: +49 711 911- 89956
Fax: +49 711 911- 82808
Email: raceparts@porsche.de

The spare parts service will be operated on-site by Manthey Servicezentrum GmbH.

The cars must comply with the requirements of these Technical Regulations. Technical acceptance of the cars is undertaken by the Technical Scrutineers.

2.2 Engine

2.2.1 General Description

- Water-cooled six-cylinder boxer engine
- Displacement 3,996 cm³; stroke 81.5 mm; bore 102 mm
- Max. rpm: 8,750 rpm
- Single throttle butterfly system
- Intake manifold with two resonance flaps
- Dry-sump lubrication with oil-water heat exchanger
- Race exhaust system with DMSB certified catalytic converter
- Engine control unit Bosch MS 6.6
- Single-mass flywheel
- Required fuel quality: minimum 98 octane, unleaded to E20.

The engines are sealed at Dr. Ing. h.c. F. Porsche AG prior to delivery. A car with an unsealed engine or with a damaged seal is not permitted to participate in the Series under any circumstances.

Any work on the engine that requires the seal to be opened is only permitted to be undertaken at Dr. Ing. h.c. F. Porsche AG. Before the engines are delivered and refitted, a new seal shall be affixed at Dr. Ing. h.c. F. Porsche AG.

Engines can be called in and inspected at the instructions of the Stewards.

An engine change has to be approved in writing by the Series Organiser prior to the change.

2.2.2 Engine Electronic Control Units

Throughout the entire event, only the engine electronic control units coded and sealed by the Series Organiser are permitted to be used.

The engine electronic control unit incl. the complete wiring harness must be used without modifications. The Series Organiser or the Technical Scrutineers reserve(s) the right to check or exchange the engine electronic control unit or record the engine characteristic data at any time during the event. The Series Organiser reserves the right to reprogram the engine electronic control units and to seal the plug-in connectors for reading the electronic control units at any time. It is thus ensured that the status of the program and data are identical for all participating cars.

The Technical Scrutineers need to be informed in writing of VIN and ECU number if an electronic control unit has the capability of traction control and/or ABS and is used in an event. Traction control and ABS have to be disabled at all times throughout the event.

It is the Competitors responsibility to ensure that the engine electronic control unit is programmed and only used with the software MS66_PAG992_GT3_0112_992GT3CUP_hp56_CC07 during each event.

The Series Organiser needs to be informed in writing (text form sufficient) **before each event** of VIN and ECU number if an electronic control unit has the capability of traction control and is to be used in that event. Traction control must be disabled at all times throughout the event.

2.2.3 Exhaust System

Contrary to the general car description (cf. 2.1), the exhaust system, starting from the manifold, for the Series will be modified completely with the parts listed in the valid parts catalogue for the respective car and model year to the version "exhaust system without silencer" (general linguistic usage as "Supercup exhaust system").

As an exception to the paragraph above, it is mandatory to use the standard exhaust system for the following events only:

- 02 Festival of Dreams (Hockenheimring)
- 06 Sachsenring
- 08 Hockenheimring

2.2.4 Engine oil quick refill

The use of the optional "oil quick filling kit" as shown in the catalogue is permitted, provided the mounting is fully compliant with the official Porsche AG mounting instructions. The hole in the engine lid necessary to fit the quick oil fill must be fully covered by clear heli tape. The use of the engine oil quick fill in pit lane during any Porsche Carrera Cup Deutschland event is prohibited.

2.3 Power Transmission (gearbox/differential lock)

2.3.1 General Description

Gear ratios:

Ring & pinion gear	15/23	$i = 1.533$
Final drive	16/39	$i = 2.438$
1st gear	13/41	$i = 3.154$
2nd gear	17/40	$i = 2.353$
3rd gear	20/37	$i = 1.8950$
4th gear	24/36	$i = 1.500$
5th gear	24/30	$i = 1.250$
6th gear	28/30	$i = 1.071$

- Porsche six-speed sequential dog-type gearbox sealed (for warranty purposes only)
- Internal pressure-oil lubrication with active oil cooling by oil-water heat exchanger
- Mechanical limited slip differential
- Three-plate sintered metal race clutch
- Paddle shift with electronic shift barrel actuator

2.3.2 Ramp Breakover Angle

The ramp breakover angle of the differential lock is 52° (traction) and 35° (overrun). The ramp angles are determined from the axis of rotation (Attachment 4). The number of friction plates and the assembly order shall correspond to the specification in the Technical Manual must not be changed. The fitted friction plates must comply in terms of part number, allocation and specification (see parts catalogue).

2.3.3 Transmission Emergency Function

When the transmission emergency function has been switched on, the car must immediately return to the pit lane. The car is not permitted to leave the pit lane again until this function has been deactivated.

2.4 Lubricant System

Not less than the minimum quantity of transmission oil in the gearbox as specified in the manual must be used at all times during the event.

The addition of any additives or any chemical changes to the engine oil are prohibited.

Engine:

Mobil 1 ESP X3 0W-40 engine oil is compulsory.

Transmission:

Mobilube 1 SHC 75W-90 transmission oil is compulsory.

2.5 Brakes

It is not permitted to modify the car to endurance brake calipers, even if they might be listed in the parts catalogue.

General Description

- Two independent brake circuits with brake pressure sensors for front and rear axle, adjustable by the Driver via brake balance system.
- Racing brake pads
- Optimized brake ducts
- Ergonomic brake pedal positioning
- Derivative sensors & harness for retrofitting an ABS system.

Only standard master brake cylinders are permitted for the 2 brake circuits on the

- Front axle: diameter 19.1 mm
- Rear axle: diameter 17.8 mm Cars delivered with brake master cylinders of 15.9 mm diameter need a replacement of the brake master cylinders with 17.8mm diameter from the 2023 parts catalogue.

Front axle:

- Aluminium 6-piston fixed callipers, one piece
- Internally vented brake discs, diameter = 380 mm, 32 mm thick mounted on aluminium disc bells

Rear axle:

- Aluminium 4-piston fixed callipers, one piece
- Internally vented brake discs, diameter = 380 mm, 32 mm thick mounted on aluminium disc bells

The use of any system working like an ABS system is strictly prohibited. For easier handling and more versatile use of the cars besides the Porsche Carrera Cup Deutschland, it is permitted to have the following parts of the ABS system offered by Porsche AG still in the car during the events of the Porsche Carrera Cup Deutschland, as long as all components are fitted complying with the official Porsche AG mounting instructions:

- ABS ADAPTER HARNESS
- G sensor ABS and TC

2.6 Wheel Suspension

Forged control arms & top mounts:

- Stiffness optimized
- Heavy-duty spherical bearings with dust protection
- Wheel hubs with center-lock wheel nut
- Shock absorbers with motorsport specific valve characteristic, non-adjustable
- Double-blade-type adjustable anti-roll bars
- Tyre pressure monitoring system

2.6.1 General Description Front Axle

- Double wishbone front suspension, adjustable ride-height, camber and toe;
- Electric power steering with manual function to ease car manoeuvring;

2.6.2 General Description Rear Axle

- Multilink rear suspension, adjustable in height, wheel camber and toe;
- Motorsport driveshafts optimized for reliability and durability;

2.6.3 Allowed adjustments

The suspension is permitted to be modified within the scope of the specified setting range. All genuine parts must be retained. The maximum permissible combined thickness of the camber spacer washers is dependent on the track for each event and is given in the table below:

Maximum value camber shims	Low stress (standard)	Medium stress	High stress
Front axle	20.0 mm	19.0 mm	18.0 mm
Rear axle	15.0 mm	13.0 mm	11.5 mm
Circuit	Hockenheimring Nürburgring Lausitzring Sachsenring	Spa-Francorchamps Zandvoort Red Bull Ring	

The non-removable spacer (part number 9F1.505.184) of the rear lower control arm will be included when determining the combined thickness of the camber spacer washers.

A change to the maximum permissible combined thickness of the spacer washers in the front and rear axle control arms and/or camber value can be announced by Stewards' bulletin at any time before or during any event.

It is permitted to fix the camber shims in position with aluminium tape.

All bearing points of the front and rear control arms must be left in the position in which they are delivered. The adjustment of the excenter screw at the front upper control arm mounting bracket, within its specified setting range, is permitted."

An alternative mounting ring may be used instead of Z Clamp Fitting (part number 9F1253543A). However, it must be ensured that the alternative clamp is not colliding with any of the other parts. The maximum permissible overhang of the alternative clamp is 10mm (cf. Attachment 10).

2.6.4 Anti-Roll Bars

The anti-roll bars are only permitted to be unhooked provided that one coupling rod of the respective rollbar is completely removed. Only the respective setting options given in the Technical Manual are permitted to be used.

The axial clearance of the anti-roll bars on the front and rear axles must be below 1.0mm. Designated shims shown in the spare parts catalogue are permitted to be used to compensate for the axial clearance.

2.6.5 Shock absorbers/springs

Only the factory-installed type shock absorbers and springs in their original condition are permitted to be used. The original delivery condition of the bump stops must not be modified in any way.

2.7 Wheels (flange + rim) and tyres

2.7.1 General Description

Single-piece light-alloy rims according to Porsche specification and design with centre lock.

- Front axle: 12J x 18 ET 23.5 mm
- Rear axle: 13J x 18 ET 44.5 mm

2.7.2 Wheels

The use of any other wheels than the originally specified wheels is prohibited. The use of tyre pressure and temperature sensors with the part number 9F1.907.275 is optional. The use of any other tyre pressure and temperature sensors is prohibited. Only the use of valve caps mentioned in the respective spare parts catalogue is permitted and they must be fitted for all sessions.

The rims are permitted to be painted. It is prohibited to paint or treat any functional surfaces (rim bed, contact area of wheel nut, mounting surface of the wheel). Rims are not permitted to be repaired. The friction strips on the inside of the rim must stay functional and must not be treated in any way.

2.7.3 Tyres

Only the version of Michelin tyres approved for the Series with the following specification and supplied by the official supplier is permitted to be used for the duration of the events and the official tests.

Slick tyres

- Front: 30/65 R 18 Porsche Cup N3
- Rear: 31/71 R 18 Porsche Cup N3R

Rain tyres

- Front: 30/65 R 18 P2L
- Rear: 31/71 R 18 P2L

Dr. Ing. h.c. F. Porsche AG suggests that all Competitors follow Michelin's recommendations and instructions relating to tyre pressure and set-up. Only atmospheric air is permitted to be used to inflate the tyres. It is not permissible to rotate the tyres on the rims. It is permitted to refit tyres, but the refitting must be performed by the official Michelin tyre supplier (Bardi).

Should the tyre manufacturer prescribe a rotational direction for their tyres, then any departure from the manufacturer's recommendation is prohibited.

2.7.4 Route to and from the pit lane

Starting with the qualifying of the first championship round the route into and from the pit lane may be taken only on registered slick tyres or rain tyres.

2.7.5 Tyre Marking

Throughout these regulations any reference to the marking of tyres includes the procedure of electronically scanning and recording the individual bar codes of tyres.

All tyres must be marked.

At each event the following quantity of tyres for each competition number can be marked by the Technical Scrutineers:

- a) Before Free Practice of the first event:
 - Four (4) slick tyres for the front axle
 - Four (4) slick tyres for the rear axle
- b) Before Free Practice of any of the following events:
 - Two (2) slick tyres for the front axle (registered at the previous event only)
 - Two (2) slick tyres for the rear axle (registered at the previous event only)
 - Two (2) slick tyres for the front axle
 - Two (2) slick tyres for the rear axle
- c) Before Qualifying (of any event):
 - Four (4) slick tyres for the front axle
 - Four (4) slick tyres for the rear axle

The number of rain tyres is unlimited.

2.7.6 Ordering of tyres

The tyres for the respective event must be ordered from Michelin in good time – at least ten working days before the start of the race event (ISC Art. 2.1.7.a refers)– using the official order form.

2.7.7 Free Practice

For the free practice session of the initial event of the respective Driver in the Series it is permitted to use two sets of tyres of the aforementioned specification purchased from the official supplier.

From the second event onwards, it is permitted to use one set of new tyres and one set of previously registered tyres of the aforementioned specification purchased from the official supplier. It is only permitted to use the previously registered slick tyres for the free practice session with the same competition number from the previous Porsche Carrera Cup Deutschland 2023 race event.

Tyres marked for free practice may not be used for Qualifying or the Races of the same event, except for the cases specified in Art. 2.7.11.

Substitute entries must use the tyres marked for the competition number they are replacing.

In case of a Team Change (cf. Art. 8.1.8), the tyres marked before the team change remain tied to the original entry at the outgoing team.

Drivers changing teams replacing another driver must use the tyres marked for the competition number they are replacing (cf. Substitute Drivers, Art. 2.7.10).

Drivers changing teams not replacing another driver and thereby causing an additional entry for the receiving team, may use one set of unmarked tyres of the aforementioned specification purchased by the receiving team from the official supplier.

2.7.8 Qualifying and Race

Only the tyres marked for the relevant event are permitted to be used for the respective qualifying and race. Only marked tyres may be taken into the pit lane for qualifying and the race of the respective event. There are no restrictions on taking and using rain tyres. It is permitted to transport rain tyres to the pit lane. For the avoidance of doubt, slick tyres marked before free practice (where this is provided for) or used during free practice may not be brought into the pit lane for, or used during, qualifying or the race.

2.7.9 Guest Drivers

For the entered event, it is permitted to use two sets of new tyres of the aforementioned specification purchased from the official supplier for the free practice.

For the entered event, a maximum of four slick tyres for the front axle and four slick tyres for the rear axle for each competition number can be marked and handed out by the Technical Scrutineers before qualifying.

For Guest Drivers entering as a Substitute for an already entered car, the rules for Substitute Drivers apply.

The number of rain tyres is unlimited.

2.7.10 Substitute Drivers

Tyres are allocated to an existing entry. The tyre rules for permanent entries apply.

2.7.11 Tyre Damage

The Technical Scrutineers have the authority to declare damaged tyres as unsafe and demand to have them replaced.

- a) Damaged tyres must be replaced with a tyre registered for Free Practice of the current event.
- b) If a competition number used up the permitted tyres and cannot replace the damaged tyre with a tyre registered for the Free Practice of the current event (cf. 2.7.11a)) which is declared safe to use, a new tyre must be registered. Using a new tyre, which was not previously registered will result in an automatic grid penalty of 3 places per new tyre for the next race the competition number competes in.

2.7.12 Treatment

Any chemical, mechanical or thermal treatment of the tyres is prohibited. Cleaning of the rims is permitted. The mechanical removal of rubber abrasion and stones is permitted. The usage of heat guns or any similar devices of any kind to help the removal of rubber abrasion and stones ("tyre scraping") is prohibited. The use of heated covers, materials or other means that change the temperature of the tyres is prohibited for the entire duration of an event. From the time of the pre-start until the end of the session the for the event approved tyres are not allowed to be

covered. This applies for slick as well as rain tyres.

2.7.13 Tyre logs

All barcodes of the marked tyres will be recorded in lists, the so-called tyre logs, which will be made available to the Competitor. The Competitor must compare the barcodes of the tyres with those of the tyre logs.

Any discrepancy between the listed barcodes and the barcodes of the tyres must be communicated by the Competitor to the scrutineers in writing until one hour before the beginning of pre-grid for the session in which the respective tyres may be used for the first time.

If there is no communication, this will be deemed as implicit acceptance of the received tyre logs.

No tyre is permitted to be used that is not listed on a tyre log for the relevant car, except for rain tyres (cf. Art. 2.7.5).

2.8 Bodywork and Dimensions

2.8.1 General Description

- Lightweight body featuring intelligent aluminium-steel composite design
- Integrated (welded) roll-cage in accordance with FIA regulations (permitted for co-driver usage on circuit events)
- Front cover with integrated quick-release fasteners; cooler exit-air duct and central air intake for cockpit ventilation
- Removable rescue hatch in accordance with the latest FIA safety regulations
- Mounting points for lifting device
- Fenders with extensions
- Widened front bumper with spoiler lip
- Rear bodywork with integrated rain light in accordance with FIA regulations

Lightweight exterior:

- Carbon-fiber reinforced plastic doors with quick release push button
- Carbon-fiber reinforced plastic rear lid with integrated quick-release fasteners; removable
- Carbon-fiber reinforced plastic adjustable rear wing with 'swan neck' mounting (11 positions)
- Polycarbonate windows with hard coating
- Rear underbody panelling with NACA ducts for brake, driveshaft and shift barrel actuator cooling

Modified 911 cockpit:

- Carbon-fiber reinforced plastic interior trim panels
- Ergonomic digital touch panel with multi-color backlight aligned towards the Driver
- Multifunctional carbon-fiber reinforced plastic motorsport steering wheel with quick release coupling, shift paddles and illuminated push buttons
- Adjustable steering column with steering angle sensor
- Safety nets (center and Driver's side) in accordance with latest FIA safety regulations
- Optimized cockpit ventilation featuring airflow directed at the Driver
- Racing bucket seat in accordance with FIA Standard 8862/2009:
- Infinite longitudinal adjustment, two positions for height and inclination adjustment

- Padding system in three sizes to adapt seat to individual Drivers (delivered with size M)
- Preparation for seat ventilation
- Six-point racing safety harness
- FT3 safety fuel cell (approx. 110 liters) and dry break couplings for fuelling and draining using a fully enclosed system
- 'Fuel-Cut-Off' safety valve in accordance with FIA regulations
- Integrated air-jack system (three jacks) with valve mounting points on either side of the car

Colors:

- Body painted with water-based paint
- Exterior: GT-silver-metallic (M7Z)
- Interior: GT-silver-metallic (M7Z), without clear lacquer finish
- Rims: Platinum semi-matt (0B5)
- Rear wing in naked carbon

2.8.2 Overall car dimensions and overhangs:

Total length:	4,585 mm (180.51 inch)	+/- 15 mm
Track width of the front axle measured at the center of wheel hub plugs	1,885 mm (74,21 inch)	+/- 10 mm
Track width at the rear axle measured at the center of wheel hub plugs	1,885 mm (74,21 inch)	+/- 10 mm
Front overhang measured from the middle of the wheel of the front axle to the leading edge of the car (first point in the direction of the longitudinal axis, incl. front lip)	1,036.0 mm (40,79 inch)	+/-15.0 mm
Rear overhang	1,081.0 mm (42,56 inch)	+/-15.0 mm
Wheelbase (measured at the wheel hubs' centers)	2,468 mm (97.16 inch)	+/-15.0 mm

2.8.3 External bodywork (including windows)

The delivery status of the bodywork must be preserved.

2.8.4 Windscreen

As a replacement to the original part, a heated windscreen as shown in the spare parts catalogue is permitted. The windscreen is permitted to be connected to the electrical system of the car and the heating function is permitted to be used.

To protect the windscreen and as a safety measure, 'tear-off' screens are permitted to be attached to the windscreen. Fitting will be checked during technical scrutineering and must be removed where applicable on request of the Technical Scrutineers.

2.8.5 Side and rear windows

Only the genuine Porsche 911 GT3 Cup side and rear windows in their original version are permissible.

Additionally, the rear window must remain fixed with the original type of fixing at all times.

2.8.6 Cockpit

2.8.6.1 Seat

The adaption of the seat by the addition of original Sabelt seat padding shown in green and blue in Attachment 6 is permitted. Each padding shape may only be used in the specific and correct location and direction as shown in Attachment 6.

Additional padding at the head rest can only be added in accordance with the following conditions and the Technical Scrutineers discretion:

- The foam used for the padding must be the same material as the one used on the head rest by the seat manufacturer.
- The padding must be properly fixed to the seat.

Any addition or removal of material below the surface shown in black is forbidden.

Any modifications or addition of paddings outside of the prescriptions above must be presented to the Technical Scrutineers for approval.

A foamed seat insert, according to FIA Appendix J, Article 253-16, may be used as long as the insert is made of fireproof material, coloured in black. The use or change is subject to approval by the Series Organiser/Technical Scrutineers.

The original seat mounting (seat rails and bracket) must be retained and must not be modified.

The provisions of FIA International Sporting Code Appendix J Article 253 - 16 must be complied with at all times.

2.8.6.2 Ventilation in the passenger compartment

Only the factory-fitted ventilation pipe (NACA-intake on the front opening hood) is permissible for cockpit ventilation. The ventilation of the windscreen must not be affected. For additional ventilation of the passenger compartment only the existing original ventilation openings in the rear back windows are permissible.

The dimension of the -intake port for cockpit ventilation at the center of the hood is permitted to be changed by taping.

2.8.6.3 Safety Nets

Every car must be equipped with the after-sales safety nets as specified in the valid spare parts catalogue and mounted complying with the Porsche AG mounting instructions.

2.8.7 Additional roof hatch accessories

The car has an opening in the roof in order to make using the KED system easier should it become necessary to rescue the Driver.

The roof hatch is connected to the roof via seven livelocks which must be accessible at all times (no foiling or painting of live locks is allowed).

2.8.8 Ground clearance of car

The minimum ground clearance of the ready-to-drive car (with the Driver in the car and slick tyres in compliance with Art. 2.7, at 2.0 bar \pm 0.1 bar air pressure) must not be less than the specified dimension, as measured at the specified measuring points, at any time during the event.

For the entire duration of the event the ground clearance of the front axle is to be a minimum of 72.0 mm and the clearance at the rear axle a minimum of 106.0 mm. The measuring points (see Attachment 5) at the front axle are the mounting bolts of the cross member/bodywork in relation to the reference surface and the machined rear surface in the direction of travel on the side section of the rear axle in relation to the reference surface. The ground clearance is permitted to be changed within the existing adjustment range.

The minimum ground clearance for the front axle must be achieved with undamaged and unmodified mounting bolts (part number N91253401).

The height of an undamaged and unmodified mounting bolt head will be defined as 14.9 mm. If the height of the mounting bolt heads, fitted to the car during the ground clearance measurement, measures less than 14.9 mm, the difference will be taken into account.

2.8.9 Measuring method

The measurement is conducted on the measuring plate during technical scrutineering. The measuring plate is available to the participating teams to check the minimum ground clearance during this period after consultation with the Technical Scrutineers. A check can also be made in the pit lane for the duration of the qualifying session.

The minimum ground clearance is checked using a measuring plate and appropriate height gauges for the axle to be measured in each case. The measurement is checked with the ready-to-drive car incl. the Driver on board, standing on the measuring plate. If the measuring gauges can be accessed under the measuring points described above, the requirement to comply with the minimum height is satisfied. Any measuring tolerances will be taken into account by the Technical Scrutineers.

The Technical Scrutineers may at any time in their absolute discretion check the ground clearance measurement with any set of tyres allocated to the respective start number and used during the session that the check is performed during or after. The Technical Scrutineers may also use instruments like a calliper or a depth gauge to determine the ground clearance.

2.8.10 Failure to reach minimum height

Failure to reach the minimum height during the qualifying session will be penalised with the cancellation of the times achieved by the Driver concerned. The Driver is permitted, however, to take up the race from the last place on the starting grid. Failure to reach the minimum height in the race will result in disqualification.

2.9 Aerodynamic devices

The original position of the wing section is permitted to be changed within the specified scope for adjustment provided by the Technical Manual.

There are 11 adjustment positions: from 4° to 14°. Each adjustment position, according to the regulations, is defined by bolt holes with matching markings as shown in the Technical Manual (cf. Attachment 8). All mounting bolts (left- and right-wing support, front and rear bolt) must use the same corresponding bolt holes.

Competitors are permitted to tape over the full area of the headlight lenses with transparent Heli tape and coloured

stickers in accordance with the Sticker Regulations (cf. Attachment 3) to indicate their class, without thereby taping over a slot in the bodywork.

Apart from the above, taping over of any slots in the bodywork, wings or other permanent parts, joints and openings is not permitted.

The use of the front air scoop (part numbers 9F1.407.811 and 9F1.407.812) is mandatory for each event.

If a session is declared as a wet session it is permitted to close all slots on the rear side windows with transparent heli tape.

Any alteration or amendment outside the above set parameters will render the car non-compliant with the Technical Regulations and may be subject to penalties from the Stewards.

2.10 Electrical equipment

2.10.1.1 General description

- 10.3" Porsche color display
- Porsche logger
- Porsche power box
- Fire extinguisher system (extinguishing agent: NOVEC gas)
- Lightweight 12 V, 60 Ah battery (LiFePO4) leak-proof, installed in co-driver's footwell
- Digital touch panel with multi-color backlight
- 175 A alternator
- Single-arm windscreen wiper with direct drive (intermittent and continuous operation)
- Three additional center console switches for additional power consumers
- Data connection (data logger, video system)

It is allowed to install the following battery charging cable from Manthey-Racing to charge and "wake up" dead batteries:

- MTH000116A – AS Charging cable

The loom must be fitted according to the latest mounting instructions.

No other additional charging loom is permitted.

Optionally, the usage of the following electrical equipment out of the Dr. Ing. h.c. F. Porsche AG and Manthey-Racing spare parts catalogue is permitted:

- AS SENSOR GPS
- Z HARNESS USB
- RLU RUGGED USB MEMORY in combination with USB Stick mounting Bracket (MTH001179A)

Optionally, the following electrical equipment maybe installed but may not be used during any session:

- GPS Antenna

It is not permitted at any time for any Competitor to read any sensors with any equipment, which are not allocated to the Competitor's own team. Any Competitor breaching this regulation may disqualified from the relevant session, race or competition.

2.10.1.2 LED Lighting system

- Main headlights
- Daytime running lights
- Taillights
- Rainlight in compliance with FIA homologation regulation

2.11 Data Transfer

The use of radio-based information transmission in the car (e. g. telemetry) is forbidden, the only exception is the usage of the built-in tyre pressure monitoring system, which uses radio transmission for its functionality.

It is forbidden to read any sensor value or data from any car not belonging to the Competitor.

From the "pre-start" to the end of the "Parc Fermé" during qualifying and racing, only the Series Organiser and personnel nominated by the Series Organiser are permitted to connect laptops/computers to the cars. For the same period, no external connection (also wireless) may be made between the car and any external equipment other than the cars equipment to read out the antennas of the tyre pressure monitoring system. It is not permitted at any time for any Competitor to read any sensors with any equipment, which are not allocated to the Competitor's own team. Any breach of this regulation may result in the car being disqualified from qualifying or racing."

2.11.1 Radio System

Only the radio system made available by the Series Organiser is approved for use. The Driver must be connected to the radio system during free practice, qualifying and the race and must be able to receive instructions from the Race Director or the Series Organiser from the point of leaving the pre-start area until the car is parked in the Parc Fermé.

Additional radio systems for communication between team staff, engineers or team managers are allowed. Drivers may only receive radio communication from the race director.

Should the radio system not be operational by the start of a session (free practice, qualifying or race), the Race Director can ban the car concerned from participating in the session until the radio is operational.

Malfunctions or damage to the system must be reported immediately to the Technical Scrutineers.

The choice of hardware for radio reception from the "Earplug" port to the Driver is optional but must be checked and approved by the Technical Scrutineers. When mounting fixed speakers in the Driver's helmet, the FIA helmet regulations must be strictly observed. In the case of any ambiguity, the Driver/Competitor must produce proof that the components used are suitable for use in the car (fire prevention, etc.).

Modifications to the system are not permitted. Extra equipment is only permitted to be coupled with the radio system by the Series Organiser.

The radio system is the property of the Series Organiser and must be returned to the organiser in proper order after the last race of the season.

Correct installation of the radio system must be approved by the Technical Scrutineers.

On written request by the Competitor, the Series Organiser may authorise that a separate radio loom can be carried in the vehicle, providing it is completely electrically disconnected from the vehicle and does not interfere with or alter any function of the vehicle or the official radio system. The installation of a separate radio loom must be approved by the Technical Scrutineers. The Series Organiser may withdraw such authorisation at any time during an event.

2.11.2 Data Recording

Use of the factory-fitted data recording system manufactured by COSWORTH is compulsory. The COSWORTH system is assigned to the car's chassis number and must not be exchanged. Only the setups approved by Porsche are permitted to be used for the duration of the event.

Only the infrared pit wall beacon signal provided by the Series Organiser may be used to create lap times in recorded data.

All recorded data relating to the free practice, qualifying or race must be made available to the Technical Scrutineers or the Series Organiser.

Any additional electrical connection to the car's wiring harness is not permitted. Installations set up by the Series Organiser are exceptions to this rule.

Where the Series Organiser requires an additional part or system to be fitted for development purposes, the Competitor is not permitted to access any of the associated data unless specific agreement is given in writing by the Series Organiser.

2.11.3 Timing Transponder

Only the transponder provided by the Series Organiser is allowed to be used throughout the entire competition.

The timing transponder must be mounted as shown in Attachment 8.

2.11.4 Cameras

Only in-board or on-board cameras which have been approved by the Series Organiser for legal sporting matters and TV purposes are permitted to be used. All participants are obliged to fit and use the cameras assigned by the Series Organiser in the respective car at the defined place according to the specifications of the Series Organiser. Installation shall take place in the team's working awning.

TV cameras will be fitted by trained personnel of the supplier designated by the Series Organiser.

VBOX equipment has to be fitted by the team according to the instructions of the Series Organiser.

The memory cards can only be removed from the cameras by the personnel nominated by the Series Organiser. Any breach of this regulation or any other unauthorised interference with the camera system can result in the car and Driver being disqualified from the event.

For image rights and copyright, see Art. 16 Part 1: Sporting Rules.

The camera system provided by the Series Organiser fully remains property of Porsche Deutschland GmbH at all times. Any damage to the camera system will be repaired at the expense of the initiator of the damage / Competitor.

Competitors/Teams are not entitled to receive the footage of the on-board cameras. It is the sole decision of the Series Organiser whether to provide the Competitors/Teams with the footage from the on-board cameras or not. Any footage provided by the Series Organiser may only be used by the Competitors/Teams for internal analysis purposes. Unless expressly authorised in writing by the Series Organiser, any other use or disclosure, in particular publication in media, is strictly prohibited. In the event of any infringement, the respective Competitor/Team shall indemnify the Series Organiser against any damage caused thereby. The Competitor shall be held jointly and wholly responsible for any infringement regarding the unauthorized use of footage by any team member (driver, mechanic etc.) or other vicarious agents who have been given access to the respective footage. Furthermore, a penalty up to and including exclusion from further participation in the Series may be imposed.

2.12 Miscellaneous

2.12.1 Seals

The following seals are affixed:

Engine:

- Valve cover, left (1x)
- Valve cover, right (1x)
- Oil pump left (1x)
- Engine control unit: Connector for control unit wiring harness (2x)

If seals and marks are applied to the car by the Technical Scrutineers or Porsche, these must not be damaged, changed or reproduced. If one or more damaged or missing seals or markings are discovered, the car can be excluded from the event.

If a seal on the engine control unit is opened to allow welding work to be carried out, the control unit must then be taken to the Technical Scrutineers for an additional inspection and then be resealed, without being requested to do so. The removed seal(s) must be handed over to the Technical Scrutineers.

Seals that have fallen off during the race or are damaged must be notified to the Technical Scrutineers in writing no later than one hour after closure of the "Parc Fermé".

2.12.2 Electronic car configuration

Throughout each event, the car must be run with the following configuration settings:

- traction control and ABS variant "Basis" and the logged channel "log_car_variant" with the value "1" visible in the display
- exhaust system setting on standard with "CW_SILENCE" visible in Racecon" and the logged channel "B_silence_pt" both with the value "0"

2.12.3 Additional fixation rear brake air duct

It is permitted to secure the two halves of the air duct element (part numbers 9F1.615.457, 9F1.615.458, 9F1.615.447 and 9F1.615.448) using cable ties around each element to prevent their separation (cf. Attachment 10).

Part 3: Attachments/Drawings

Attachment 1 - Badge regulations 2023*

All teams registered for the Porsche Carrera Cup Deutschland 2023 will receive a sufficient number of the compulsory badges to be sewn onto their Drivers' overalls prior to the first race event. All compulsory badges must be positioned on the Drivers' overalls as prescribed.

Please note that when embroidering or sewing badges onto race suits homologated to comply (FIA Standard 8856-2000) the following applies:

Embroidery sewn directly onto the race suit should only be stitched onto the outermost layer. The use of flame-retardant material (NOMEX) in accordance with ISO 15025 is recommended.

The backing on badges must be made of flame-retardant material (NOMEX) in accordance with ISO 15025. Only flame-retardant thread (NOMEX) in accordance with ISO 15025 should be used to sew on the badges. The use of flame-retardant thread (NOMEX) in accordance with ISO 15025 is also recommended on the badges themselves. The use of iron-on badges is not permitted.

Any embroidery or affixing of badges not complying with these conditions will result in the cancellation of the homologation of the overalls concerned.

The following picture replaces the previous picture

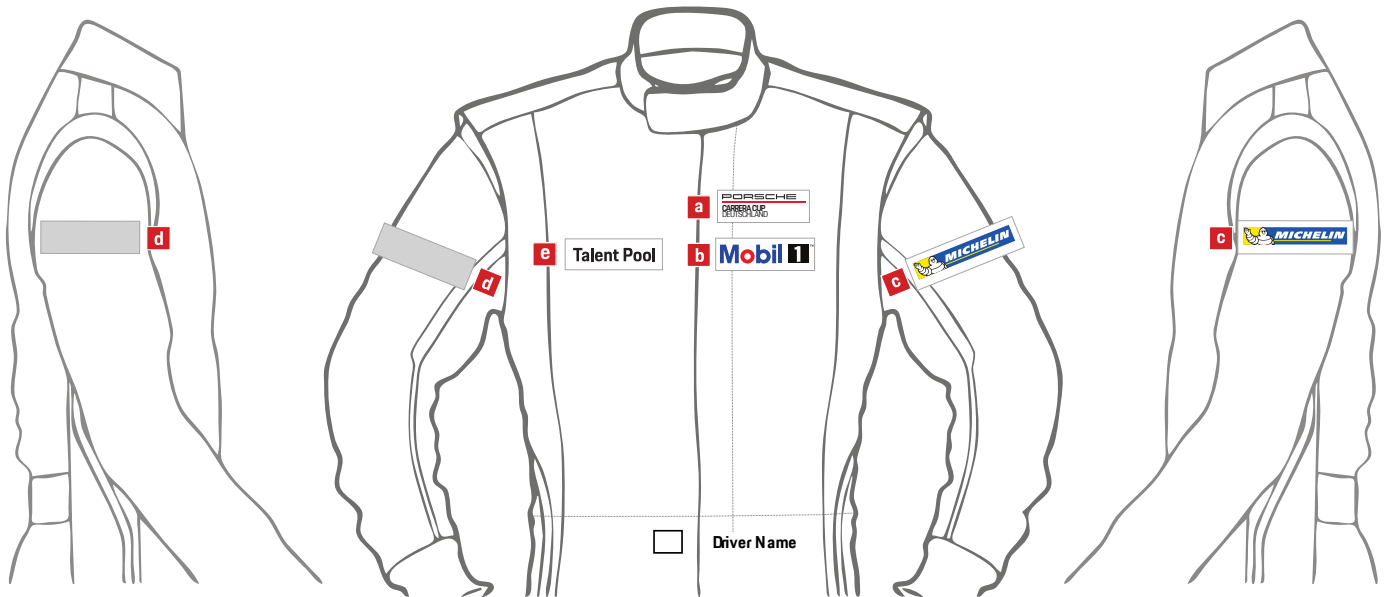

Please affix the compulsory badges in the following positions:

- a. Porsche Carrera Cup Deutschland Logo (width 130 mm)
- b. Mobil 1 Logo (width 130 mm)
- c. Michelin Logo (width 130 mm)
- d. Reservation Porsche (width 130 mm)
- e. Porsche Carrera Cup Talent Pool (width 130 mm)

*Subject to amendments.

Attachment 2 - Sticker Regulations 2023

All teams registered for the Porsche Carrera Cup Deutschland 2023 will receive a sufficient number of the compulsory stickers to be stuck onto the competing cars prior to the first event. All compulsory stickers must be positioned on the cars as prescribed.

PORSCHE

CARRERA CUP DEUTSCHLAND

Sticker Regulations 2023

	Overall	ProAm	Rookie
Competition No.	22	22	22
Headlights		X	X
Front bumper			

<- on light backgrounds (Position 12 and 13)

<- on dark backgrounds (Position 12 and 13)

Sticker Regulation 2023 – Porsche 911 GT3 Cup (992)

No.	Variant	Quantity	Size (mm)	Colour	Logo / Symbol	Placement
1	w	2	200 height	white	Competition number, Pro drivers	Windscreen, top right; Rear window, top center
1	b	2	200 height	blue	Competition number, ProAm drivers	Windscreen, top right; Rear window, top center
1	o	2	200 height	orange	Competition number, Rookie drivers	Windscreen, top right; Rear window, top center
2	l	1	360 x 308	white with black frame	Competition number plate, Series identification	left door
2	r	1	360 x 308	white with black frame	Competition number plate, Series identification	right door
3	s	2	35 height	black	www.porsche.com	A-pillar, left and right
3	w	2	35 height	white	www.porsche.com	A-pillar, left and right
4	s	1	526 x 32	black	Porsche Logotype (applies for 911 GT3 Cup only)	Rear lid
4	w	1	526 x 32	white	Porsche Logotype (applies for 911 GT3 Cup only)	Rear lid
5	s	1	256,5 x 40	black	GT3 Cup (applies for 911 GT3 Cup only)	Rear lid
5	w	1	256,5 x 40	white	GT3 Cup (applies for 911 GT3 Cup only)	Rear lid
6		1	207 x 107		Flash for current interrupter+ E for extinguisher mounting of integral two-mount rescue device	Front bonnet, left
7		2		red with white outline		Roof
8		1	1244,5 x 133,7		Porsche Logotype	Windscreen
9		1	557 x 120	MICHELIN original colours	MICHELIN (Challenges & Trophies as per individual contract)	Front bumper
10		2	255 x 50	TAG Heuer original colours on black	TAG Heuer	Area above daytime running light unit
11		1	527 x 97		Reservation PORSCHE	Front bumper
12		1		background: black, logo: white	Isolated team logo permitted. No further branding	Center radiator mesh
13		2		black	Masking only permitted when central radiator has already been completely masked, please refer to the technical manual	Side radiator mesh, left and right
14		2	280 x 66	MOBIL 1 original colours	MOBIL 1 (Challenges & Trophies as per individual contract)	Front bumper, left and right
15		1	280 x 66	MOBIL 1 original colours	MOBIL 1 (Challenges & Trophies as per individual contract)	Rear bumper, affixed on delivered plate
16		2	280 x 56	MICHELIN original colours	MICHELIN (Challenges & Trophies as per individual contract)	Rear bumper, left and right
17		2			Reservation PORSCHE	Side sill, left and right
18		2			Reservation PORSCHE	Side sill, left and right
19		2			Reservation PORSCHE	Side sill, left and right
20		2	210 x 85,5	white on black	PORSCHE Esports Carrera Cup Deutschland	Side sill, left and right
21		2	182 x 77	white on black	HUGO BOSS	Side area, left and right
31		2	100 x 200	white	driver name	windscreen upper right, rear window upper middle
32	s	2	50 height	black	driver name	roof side panel left and right
32	w	2	50 height	white	driver name	roof side panel left and right
33		2	160 height	black	competition number	door left and right, number panel
34		2	244 x 36	white	#CarreraCupDE	lower window frame left and right
35	s	2	210 x 85,5	black	PORSCHE E-Sport	
35	w	2	210 x 85,5	white	PORSCHE E-Sport	
36		2	300 x 54,4	white or black	Talent Pool	rear-wing side panel left and right
37	s	2	143 x 26	black	Talent Pool	exterior mirrors, left and right
37	w	2	143 x 26	white	Talent Pool	exterior mirrors, left and right
38		2	46 x 51	bronze	trophy sticker	roof side panel left and right (*not mandatory)
38		2	46 x 51	silver	trophy sticker	roof side panel left and right (*not mandatory)
38		2	46 x 51	gold	trophy sticker	roof side panel left and right (*not mandatory)
39		2		blue or yellow	headlight sticker (blue for ProAm, yellow for rookie)	headlights, left and right
40	w	2		white	markup line sticker (white for Overall, blue for ProAm, yellow for Rookie)	front bumper
40	b	2		blue	markup line sticker (white for Overall, blue for ProAm, yellow for Rookie)	front bumper
40	y	2		yellow	markup line sticker (white for Overall, blue for ProAm, yellow for Rookie)	front bumper

Please note:

1. The obligatory stickers are to be obtained from the local Porsche Series Organisation only.
2. The minimum space between stickers must be at least 30 mm.
3. The sticker positions 1-40 are strictly reserved for Porsche AG, Porsche Deutschland GmbH and their series and cooperation partners.
4. Any positions which are reserved for but not occupied by Dr. Ing. h.c. F. Porsche AG, they shall be available until availability is revoked. Such revocation shall be announced in good time by the Series Organiser, at least four weeks prior to the revocation taking effect.
5. All positions in direct visibility of the on-board cameras (dashboard etc.) in the interior and exterior areas of the racing car are reserved for Dr. Ing. h.c. F. Porsche AG and cannot be used by the Competitors.
6. Usage of current or historic livery of Porsche Motorsport works racing vehicles is reserved for Porsche AG.

Exclusivity Rule

Advertising of team partners that compete to partners of Porsche AG, Porsche Carrera Cup, Challenges or Trophies and/or cooperation partners shall be prohibited. In regards to the exclusivity of the partners of Porsche AG following rules apply. The exclusivity rule refers to the industry sector or to the product range of a manufacturer.

1. **Mobil 1** is the exclusive partner of the Porsche Carrera Cups worldwide for lubricants, thus prohibiting teams to communicate or advertise for companies or products that are Competitors of Mobil 1 lubricants.
For the area of fuels, teams are allowed to communicate or advertise for other companies under the following conditions and subject to final approval of Porsche AG:
 - Only fuel product brands will be communicated and not the respective company names of potential sponsors. The product brand of the respective "fuel" has to be clearly distinguishable from the company brand, e.g. "V-Power" or "Ultimate".
 - A maximum of one team with 3 race cars may communicate or advertise for one fuel brand. The date of the contract signing is pivotal.
Any fuel team sponsorship is required to be approved by Porsche AG prior to signature of any agreement between a team and a potential fuel sponsor.
2. **Michelin** is the exclusive partner of the Porsche Carrera Cups worldwide and as per contract for several Challenges & Trophies. Therefore, it is forbidden to teams to communicate or advertise for companies or products that are Competitors of Michelin.
3. **HUGO BOSS** is the exclusive partner of the Porsche Carrera Cups and Sprint Challenges worldwide regarding apparel and team wear. The exclusivity is limited to the relationship with Porsche, not to the advertising space on the race cars, which is available to customer teams. This means, teams can still show their own apparel partner on the car, as long as the HUGO BOSS logo is on the car as well. Furthermore, a maximum of four race cars per series may be exempted from the obligation to show the HUGO BOSS logo, decision of exemption is up to markets.
4. **TAG Heuer** is the exclusive partner regarding watches and jewellery. The exclusivity is limited to the relationship with Porsche, not to the advertising space on the race cars, which is available to the customer teams. This means teams can still show their own chronographs, professional timekeeping pieces, wall clocks and other timing equipment partner on the car, as long as the TAG Heuer logo is on the car as well. Furthermore, a maximum of four race cars per series may be exempted from the obligation to show the TAG Heuer logo, decision of exemption is up to markets.

There is no exception for partners of exclusivity.

For questions or additional information, please contact the Series Organiser, Mr Hurui Issak (hurui.issak@porsche.de) or Mr Dominik Sitzer (carreracup@porsche-veranstaltungen.de).

Attachment 3 - Ballast weights

Ballast position on the front right side of the ballast plate that is mounted on the passenger seat mounting points.

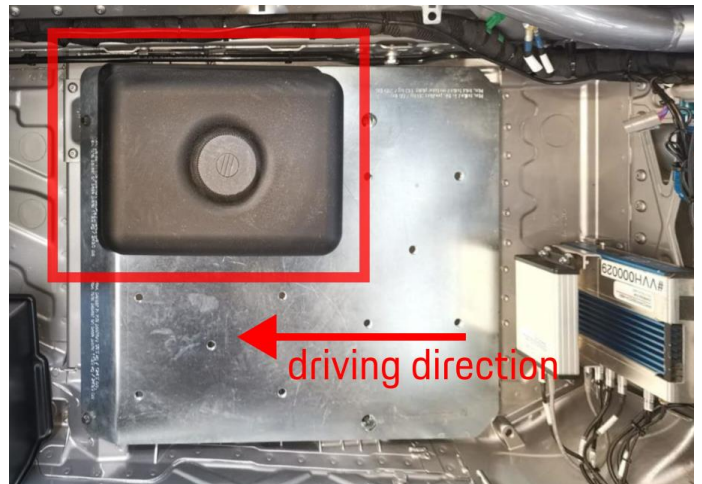
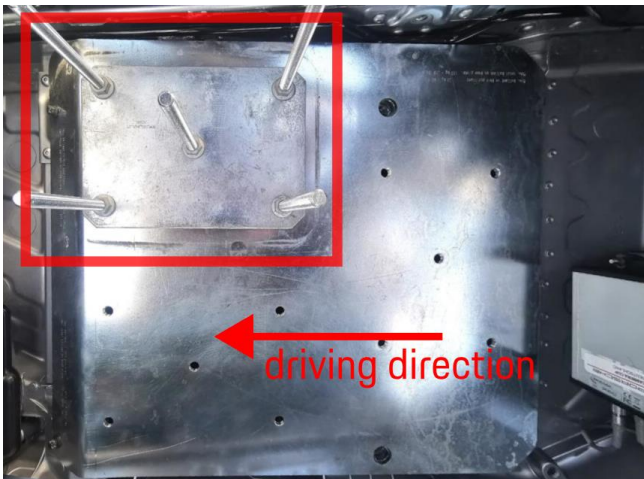

Attachment 4 - Differential lock ramp breakover angle

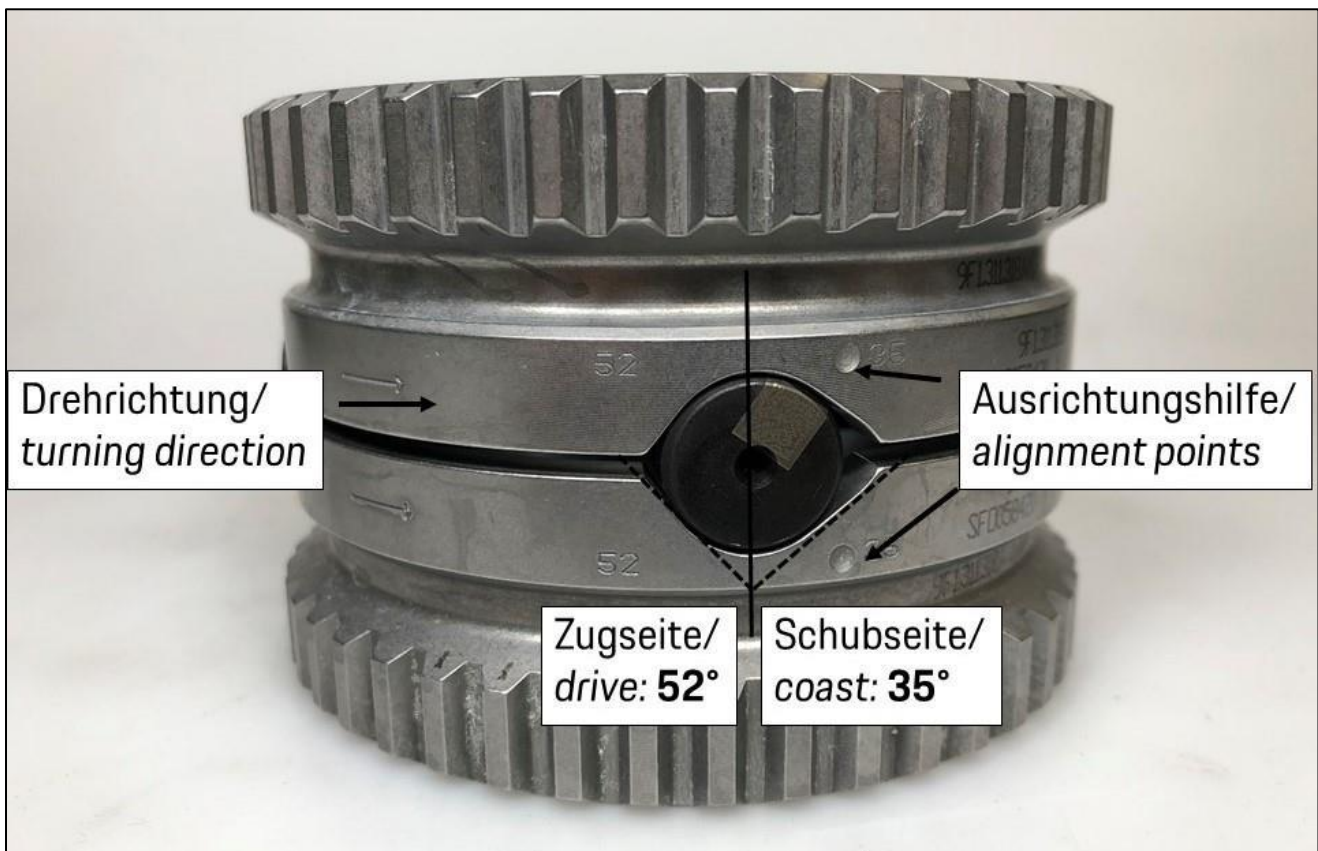

Attachment 5 - Ride height measuring points

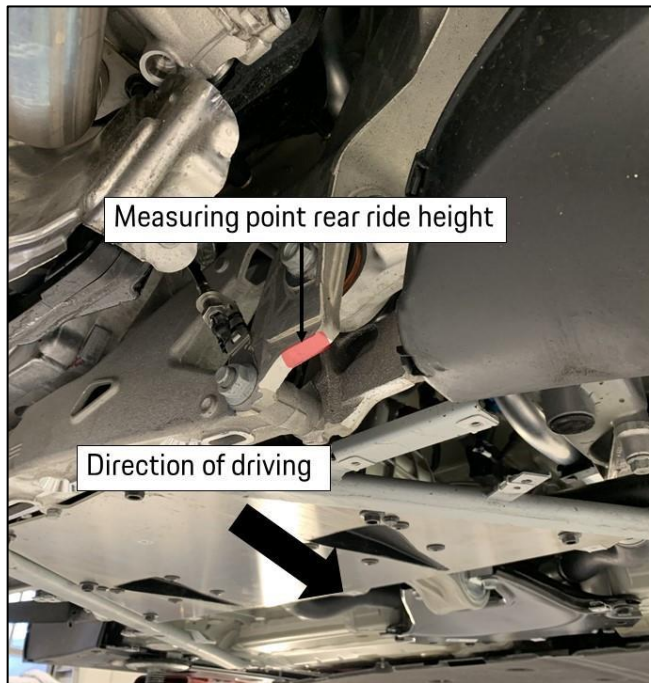
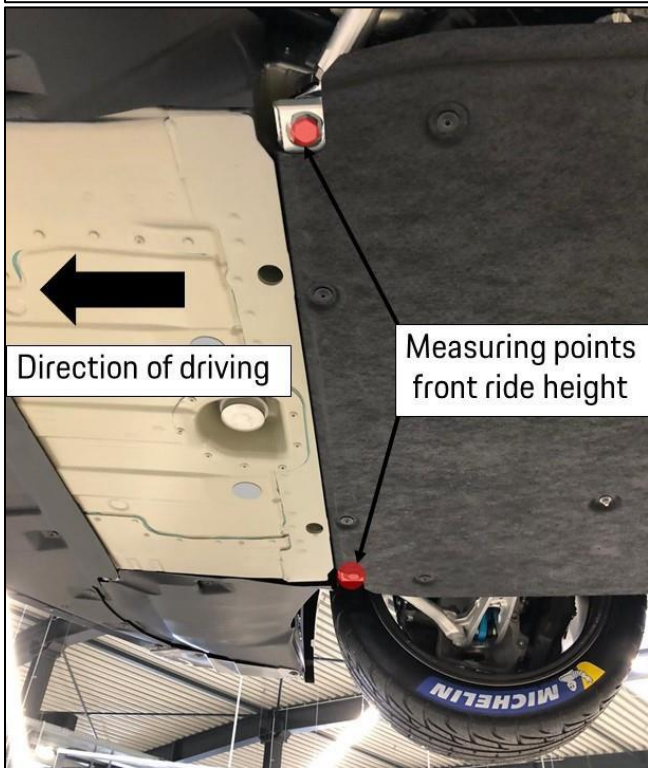
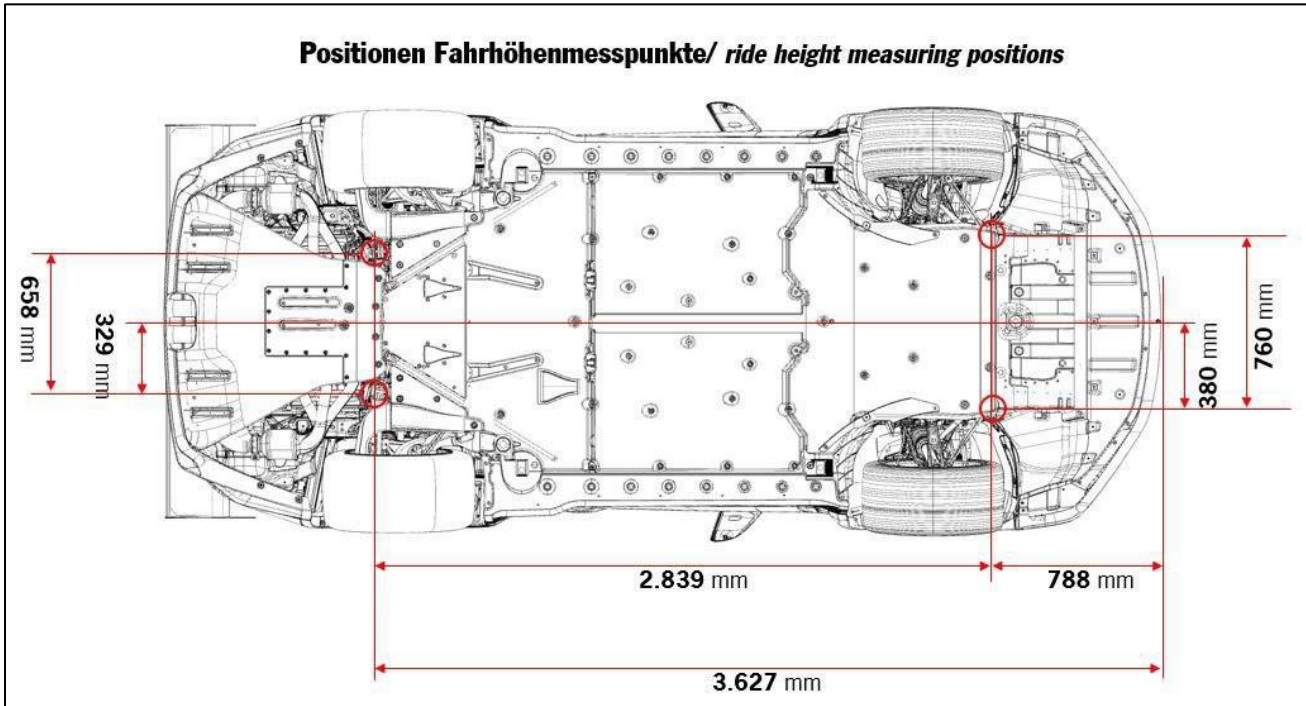

Attachment 6 - Seat Padding

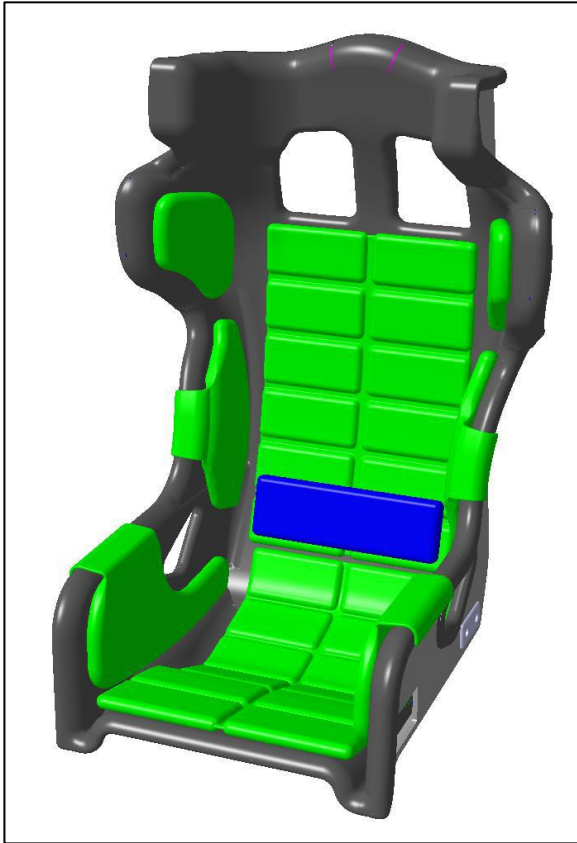

Attachment 7 - Timing Transponder Position

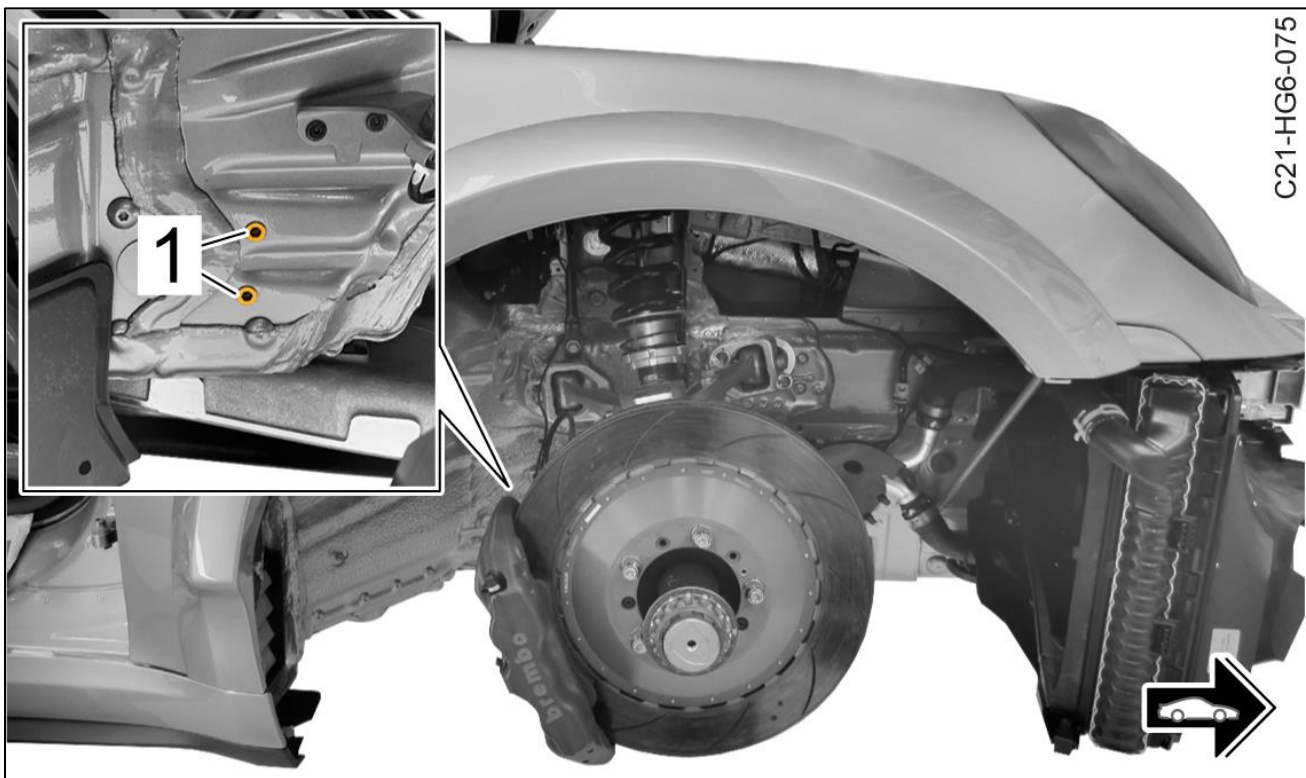

Attachment 8 - Rear-Wing Adjustment Positions

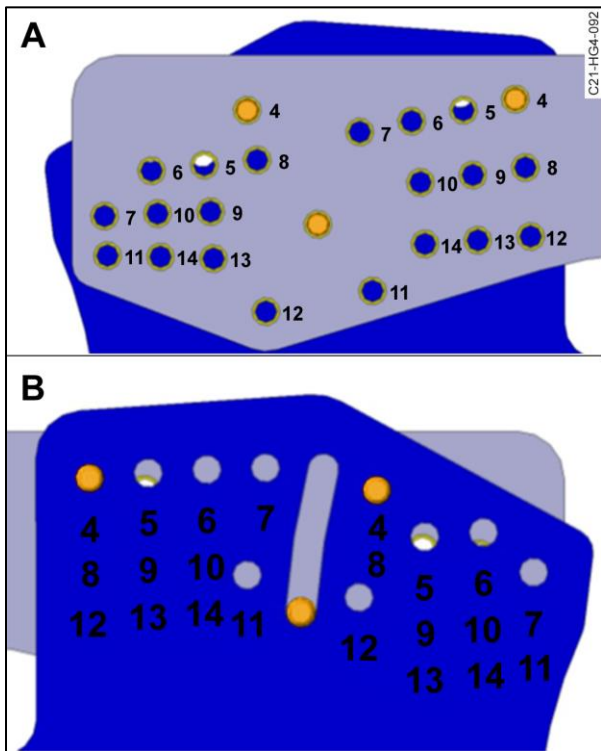

Attachment 9 - Parts Numbers

Part	Number	Alternative number (previous model)
AUXILIARY WEIGHT 2KG/6MM	9F1801141	99150484800
AUXILIARY WEIGHT 3,5KG/10MM	9F1801141A	99150484801
AUXILIARY WEIGHT BIG 6,8KG/20MM	9F1801141B	99150484802
COVERING AUXILIARY WEIGHT	9F1801575	9915048659B
KNURLED NUT COVERING	WHS001903	9915048529B
WHEEL NUT LEFT	9F1412157	9973313079A
WHEEL NUT RIGHT	9F1412158	9973313089A
Z CLAMP MOUNTING RING	9F1253543A	ANY

Attachment 10 - Alternative Z-Clamp Mounting

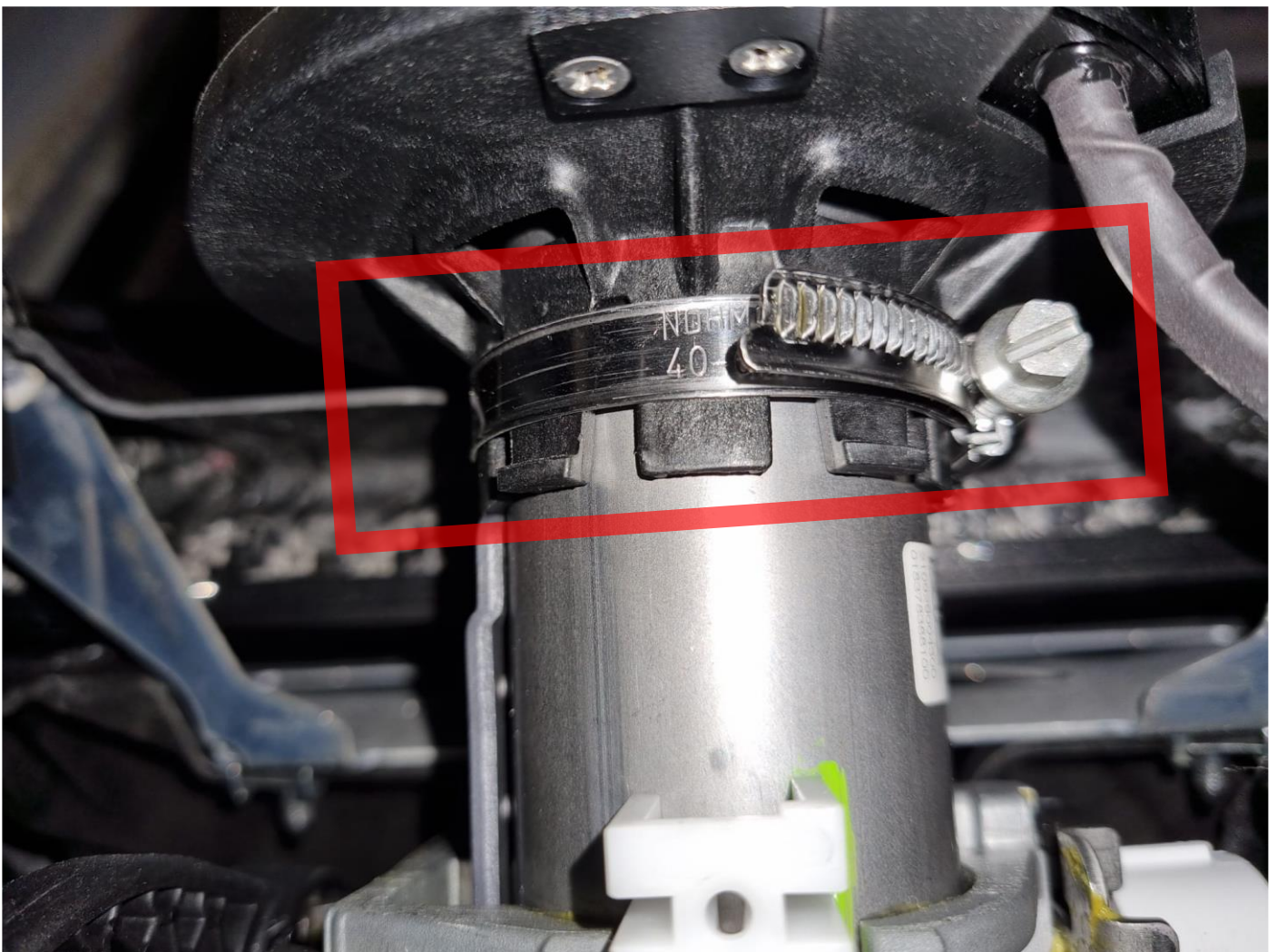

Attachment 11 - Table of Penalty Guidelines

The penalties below will be guidelines to the Stewards.

The Stewards may impose any penalty they deem appropriate for any breach of the regulations.

Offence	Art.	Practice	Qualifying	Races	Other
General					
Non-participation in a championship round	Part 1, Art. 4.1.11				EUR 3,000
Non-attendance or incomplete attendance in Drivers Briefing	Part 1, Art. 10.2				EUR 200 substitute briefing with the Race Director must be attended before entering the track.
Non-attendance or incomplete attendance in an official meeting (e.g. Team Manager Meeting)	Part 1, Art. 10.2				EUR 200
Failure to attend an Award Ceremony (e.g. End of Season Gala, Night of Champions)	Part 1, 13.2.11				EUR 2,500
Failure to follow instructions of the Series Organiser in the Paddock	Part 1, Art. 17.2				EUR 500
Failure to wear the tyre manufacturer's hat on the podium	Part 1, Art. 17.4				EUR 2,500
Failure to comply with advertising regulations (e.g. car liveries, driver overalls etc.)	Part 2, Art. 1.9.1				First Time: EUR 1,000 per violation Second time: EUR 2,000 per violation Third time: EUR 5,000 per violation
Unauthorized use of media content	Part. 2, Art. 2.11.4				up to exclusion from participation in the Series
Display of unauthorised sponsorship badges at podium	Part 2, Art. 1.9.2			EUR 2,500	
Failure to comply with paddock setup/dismantling times	Part 1, Art. 17.1				EUR 1,000
Use of non-approved structures	Part. 1, Art. 18.3 o)				EUR 2,000 per car
Operating a team hospitality	Part 1, Art. 17.1				EUR 1,000

Offence	Art.	Practice	Qualifying	Races	Other
Disobeyed marshals/officials' instructions	Part 1, Art. 3.3	Deletion of lap time + EUR 500	Deletion of lap time + EUR 500	Penalty lap / Drive-through penalty / 5 seconds time penalty (minimum)	
Disrespecting 3-minute signal	Part 1, Art. 12.6g)			Warning Flag, minimum 5 seconds time penalty (repeated offenses).	
Team failure to clear the grid before 1-minute signal	Part 1, Art. 12.6 g)			Warning Flag, minimum 5 seconds time penalty (repeated offenses).	
Technical					
Underweight	Part 2, Art. 1.6		Disqualification	Disqualification	
Violation of tyre regulations	Part 2, Art.2.7	Deletion of all lap times	Disqualification	Disqualification	
Failure to attend post session weighting	Part 2, Art. 1.6	Deletion of all lap times	Disqualification	Disqualification	
Breach of Parc Fermé regulations	Part 1, Art. 11.2.2		Disqualification	Disqualification	
Pit					
Reverse under own power in pit lane	Part 1, Art. 18.3a)	Drop of 5 grid positions (minimum)	Drop of 5 grid positions (minimum)	Drive-through penalty	
Speeding in the pit lane	Part 1, Art. 18.2	EUR 200 + EUR 25 per kph	EUR 200 + EUR 25 per kph	Penalty lap / Drive-through penalty / 5 seconds time penalty (minimum)	
Crossing white line at pit entry or exit	Part 1, Art. 18.2f)	Drive-through penalty + reprimand	Drive-through penalty + reprimand	Penalty lap / Drive-through penalty / 5 seconds time penalty (minimum)	
Entering the pit lane after the race was suspended	Part 1, Art. 12.7			Drive-through penalty	
Start					
Unauthorised practice starts	Part 1, Art. 18.3i)	Drop of 3 grid positions (minimum)	Drop of 3 grid positions (minimum)	Drive-through penalty	
False start	Part 1, Art 12.6o)			Drive-through penalty / 5 seconds time penalty (minimum)	
Overtaking before the re-start (Safety Car)	Part 1, Art. 12.14			Drive-through penalty / 5 seconds time penalty (minimum)	

Offence	Art.	Practice	Qualifying	Races	Other
Flags					
Failure to slow down under Yellow	Part 1, Art. 18.3 c)	Drop of 3 grid positions (minimum)	Drop of 3 grid positions (minimum)	Drive-through penalty / 10 seconds time penalty	
Overtaking under Yellow flag	Part 1, Art. 18.3 c)	Drop of 5 grid positions (minimum)	Drop of 5 grid positions (minimum)	Drive-through penalty / 10 seconds time penalty	
Failure to comply with Blue flag	Part 1, Art. 18.3 c)	Reprimand	Drop of 3 grid positions (minimum)	Drive-through penalty / 5 seconds time penalty (minimum)	
Failure to comply with Black & Orange flag	Part 1, Art. 18.3 c)	Deletion of all lap times	Deletion of all times	Disqualification	
Failure to comply with Red flag	Part 1, Art. 18.3 c)	Deletion of all lap times	Deletion of all times	Disqualification	
Passing Chequered flag more than once	Part 1, Art. 18.3j)	Reprimand / Drop of 3 grid positions (minimum)	Reprimand / Drop of 3 grid positions (minimum)	Reprimand / Drop of 3 grid positions (minimum)	
Driving Standards					
Causing a session to be stopped	Part 1, Art. 12.1				
Driving unnecessarily slowly, erratically or in a potentially dangerous manner whilst FCY is engaged	Part 1, Art. 12.14	Reprimand / Drop of 3 grid positions (minimum)	Reprimand / Drop of 3 grid positions (minimum)	Drive-through penalty / 5 seconds time penalty (minimum)	
Track limit violation	Part 1, Art. 17.8	Deletion of lap time 3 min Stop-&-Go Penalty (minimum; repeated offences)	Deletion of lap time	Reprimand	
Overtaking behind the Safety Car	Part 1, Art. 12.14			Drive-through penalty / 5 seconds time penalty (minimum)	
Causing a collision	Part 1, Art. 18.3b)	Reprimand / Drop of 3 grid positions (minimum)	Reprimand / Drop of 3 grid positions (minimum)	Reprimand / Drive-through penalty / 5 seconds time penalty (minimum)	
Forcing another Driver off track	Part 1, Art. 18.3b)	Reprimand / Drop of 3 grid positions (minimum)	Reprimand / Drop of 3 grid positions (minimum)	Reprimand / Drive-through penalty / 5 seconds time penalty (minimum)	
Impeding another car	Part 1, Art. 18.3b)	Reprimand	Drop of 3 grid positions (minimum)	Drive-through penalty / 5 seconds time penalty (minimum)	
Rejoining the track in different / unsafe place	Part 1, Art. 17.9 & Art. 18.3b)	Reprimand / Drop of 3 grid positions (minimum)	Reprimand / Drop of 3 grid positions (minimum)	Drive-through penalty / 5 seconds time penalty (minimum)	

Offence	Art.	Practice	Qualifying	Races	Other
Gaining an unfair advantage (e.g. overtaking off track without returning the position)	Part 1, Art. 17.9 & Art. 18.3b)	Deletion of lap time + Reprimand	Deletion of lap time + Reprimand	3 seconds time penalty (minimum; repeated offenses).	