

PORSCHE

The background of the cover is a blurred photograph of a race track pit lane. In the foreground, a yellow Porsche race car is visible, with its headlights on. The car has 'JO' and 'BEA' visible on its side. To the right, a blue helmet with 'ADA COSMETICS' is visible. The overall scene is dynamic and captures the atmosphere of a motorsport event.

**MOBIL 1
SUPERCUP**

REGULATIONS

2024



**General Regulations for
Series run on Circuits / Automobile Sport**
(as 01.03.2024)

Name of the Series: **Porsche Mobil 1 Supercup**
DMSB Visa Number: **211/24.**
Status of the Series/Events: International

Dr. Ing. h.c. F. Porsche AG, hereinafter called the Series Organiser, is hosting the Porsche Mobil 1 Supercup for 2024.

Organisation: Dr. Ing. h.c. F. Porsche AG
Porsche Mobil 1 Supercup Organisation
Porschestraße 911
71287 Weissach
Germany

Contact: Oliver Schwab, Project Manager Porsche Mobil 1 Supercup
Mobile: +49 170 911- 2976

Homepage: porsche.com/pmsc
E-Mail: oliver.schwab@porsche.de

Table of Contents

- Part 1: Sporting Regulations..... 7**
- 1 Introduction 7**
- 2 Organisation..... 8**
 - 2.1 Series Organiser.....8
 - 2.2 Name of the parent ASN8
 - 2.3 ASN Visa/Registration number.....8
 - 2.4 Organising Committee and Sporting Committee.....9
 - 2.5 List of Permanent Officials.....9
- 3 Regulations and legal basis of the Series 10**
 - 3.1 Official language.....10
 - 3.2 Responsibility, changes to the rules of participation and cancellation of an event10
 - 3.3 Porsche Mobil 1 Supercup Code of Good Conduct11
- 4 Entries and Series Classifications..... 12**
 - 4.1 Applications/entries, closing dates and acceptance information12
 - 4.2 Driver Classifications of the Series15
 - 4.3 General Entry Terms & Obligations.....18
 - 4.4 Entry fees.....20
 - 4.5 Competition numbers.....23
- 5 Licences 23**
 - 5.1 Licence requirements23
 - 5.2 Conditions for Competitors outside their national territory24
- 6 Insurance, liability exclusion and disclaimer 24**
 - 6.1 Organiser’s/promoter’s insurance.....24
 - 6.2 Declaration by the Competitor and Driver on the exclusion of liability, disclaimer of the car owner24
- 7 Events..... 25**
 - 7.1 Calendar of events25
 - 7.2 Maximum number of cars authorised25
- 8 Points for Classification 26**
 - 8.1 Awarding of points.....26
 - 8.2 Table of points28
 - 8.3 Equality of points.....29
 - 8.4 Publication of points29
- 9 Title, prize money and trophies..... 29**
 - 9.1 Title Overall Winner29
 - 9.2 Prize Money and trophies29
- 10 Private practice and testing 34**
- 11 Administrative Checks & Meetings 34**
 - 11.1 Timetable for administrative checks.....34
 - 11.2 Drivers’ briefing.....34
 - 11.3 Team Managers’ meeting35
 - 11.4 Official meetings / press conferences / representation meetings.....35
 - 11.5 Notice Board.....35
- 12 Scrutineering/technical checks 35**
 - 12.1 Initial Scrutineering36

12.2	Subsequent Scrutineering.....	36
13	Running of the competitions.....	37
13.1	Pre-Start.....	37
13.2	Practice.....	37
13.3	Qualifying.....	38
13.4	Full Course Yellow.....	41
13.5	Starting Grid.....	41
13.6	Starting modes.....	42
13.7	Races.....	42
13.8	Start procedure.....	43
13.9	False Starts.....	45
13.10	Stopping or suspending a race.....	45
13.11	Change of weather conditions.....	46
13.12	Safety Car.....	47
13.13	Finish.....	48
14	Protests, Right of Review and appeals.....	48
15	Choice of Law, Exclusion of jurisdiction of a court and limitation of liability.....	49
16	TV rights/advertising and television rights.....	50
17	Specific Regulations.....	50
17.1	Paddock.....	50
17.2	Pit lane allocation.....	52
17.3	Instructions of the Series Organiser and Officials.....	52
17.4	Publication obligation.....	52
17.5	Podium ceremony.....	52
17.6	Stewards' Inquiries.....	53
17.7	Incidents.....	53
17.8	Penalties.....	54
17.9	The track.....	56
18	Safety.....	57
18.1	Extrication exercise.....	57
18.2	Pit lane safety.....	57
18.3	General safety.....	59
Part 2:	Technical Regulations.....	62
1	Technical Series Regulations.....	62
1.1	Summary of the eligible groups/classes.....	62
1.2	Principles of the Technical Regulations.....	62
1.3	General/preamble.....	63
1.4	Permitted modifications and installations.....	64
1.5	Driver equipment.....	64
1.6	Minimum weights and ballast.....	65
1.7	Emissions regulations.....	69
1.8	Noise regulations.....	69
1.9	Advertising and partnerships.....	69
1.10	Safety equipment.....	71
1.11	Fuel type and single fuel.....	72
1.12	Technical definitions.....	73
2	Specific Technical Regulations.....	74

- 2.1 General information74
- 2.2 Engine74
- 2.3 Power transmission (gearbox/differential lock)76
- 2.4 Lubrication system76
- 2.5 Brakes77
- 2.6 Wheel suspension78
- 2.7 Wheels (flange + rim) and tyres79
- 2.8 Bodywork and dimensions82
- 2.9 Aerodynamic devices86
- 2.10 Electrical equipment86
- 2.11 Miscellaneous89
- Part 3: Environmental Regulations..... 91**
- 1 Introduction 91**
- 2 General Environmental Regulations and Guidelines 91**
- 2.1 Protection of the Ground, Water and Air91
- 2.2 Sound Levels93
- 2.3 General Paddock Activities.....93
- 2.4 Travel & Accommodation94
- 2.5 HGV Tractor Units.....94
- 2.6 Emergency & Incident Preparedness94
- 2.7 Publicity / Advertising94
- 2.8 After the event95
- 3 Specific Team Environmental Regulations and Guidelines..... 95**
- 3.1 Collection of Hazardous Liquids / Environmental Mat95
- 3.2 Disposal of Hazardous Liquids96
- 3.3 Tyre Cleaning.....96
- 3.4 Fuel97
- 3.5 Gravel.....97
- 3.6 Engines.....97
- 3.7 Storage of Fuel, Oils & Chemicals97
- Part 4: Attachments / drawings 98**
- Attachment 1 – Badge Regulations 2024*98
- Attachment 2 – Sticker Regulations 2024 (1/6) *99
- Attachment 2 – Sticker Regulations 2024 (2/6)*100
- Attachment 2 – Sticker Regulations 2024 (3/6)*101
- Attachment 2 – Sticker Regulations 2024 (4/6)*102
- Attachment 2 – Sticker Regulations 2024 (5/6)*103
- Attachment 2 – Sticker Regulations 2024 (6/6)*104
- Attachment 3 – Ballast weights105
- Attachment 4 – Differential lock ramp breakover angle105
- Attachment 5 – Ground clearance measuring points106
- Attachment 6 – Seat padding107
- Attachment 7 – Timing Transponder Position108
- Attachment 8 – Tyre Tables109
- Attachment 9 – Paddock Presentation (1/5).....110
- Attachment 9 – Paddock Presentation (2/5).....111
- Attachment 9 – Paddock Presentation (3/5).....112
- Attachment 9 – Paddock Presentation (4/5).....113

Attachment 9 – Paddock Presentation (5/5).....	114
Attachment 10 – Table of Penalty Guidelines (1/3).....	115
Attachment 10 – Table of Penalty Guidelines (2/3).....	116
Attachment 10 – Table of Penalty Guidelines (3/3).....	117
Attachment 11 – Alternative Part Number Reference Table.....	118

These Regulations consist of 118 pages incl. 11 attachments.

Part 1: Sporting Regulations

1 Introduction

The Porsche Mobil 1 Supercup Series, hereinafter called the Series, is organised in conformity with the provisions of the International Sporting Code and its appendices (the Code) and the National Sporting Regulations of the DMSB. It will be run in conformity with these Sporting, Technical and Environmental Regulations, the Technical Regulations being in conformity with the safety prescriptions of Article 277 of Appendix J to the FIA International Sporting Code.

The Series will be run in accordance with the above regulations. For the avoidance of doubt, should there be any inconsistency or conflict between the individual sets of regulations, then the order of priority shall be firstly those of the International Sporting Code, then the Porsche Mobil 1 Supercup Regulations, followed by the DMSB Regulations. Matters relating to a specific competition will be included within the Supplementary Regulations for the relevant event.

The Series in 2024 consists of 8 races organised as circuit races. However, the Series Organiser reserves the right to invoke the provisions of Articles 3.2(c) and 13.7 should circumstances mean it is not possible to run all 8 races.

The Series is supported by the following companies*:

- Michelin Reifenwerke AG & Co. KGaA
- ExxonMobil Oil Corporation - Mobil 1
- Banque Havilland
- PUMA International Sports Marketing B.V.
- ExxonMobil Product Solutions Company - ESSO
- HUGO BOSS AG
- Brauerei C.& A. Veltins GmbH & Co. KG
- Stilo srl
- Sacred Tea & Coffee

* Subject to change

Terms used within these regulations such as 'event' and 'competition' are defined as in the FIA International Sporting Code Article 20 (Definitions). Within these regulations, terms referring to natural persons are applicable to all genders.

2 Organisation

2.1 Series Organiser

Dr. Ing. h.c. F. Porsche AG, hereinafter called the Series Organiser, is hosting the Series in 2024.
The permanent office address of the Series Organiser is:

Dr. Ing. h.c. F. Porsche AG
Porsche Mobil 1 Supercup Organisation
Porschestraße 911
71287 Weissach, Germany

Contact:

Oliver Schwab
Project Manager Motorsport - Porsche Mobil 1 Supercup
Mobile: +49 170 911 – 2976
E-Mail: oliver.schwab@porsche.de

Valeska Nikola
Organisation - Porsche Mobil 1 Supercup (Contracted Representative)
Mobile: +49 170 911 – 4845
E-Mail: extern.valeska.nikola@porsche.de

Dominik Quosdorf
Technical Support Delegate - Porsche Mobil 1 Supercup
Mobile: +49 170 911 – 2487
E-Mail: dominik.quosdorf@porsche.de

2.2 Name of the parent ASN

DMSB – Deutscher Motor Sport Bund e.V.
Hahnstraße 70
60528 Frankfurt-Germany
Homepage: www.dmsb.de
E-Mail: info@dmsb.de

2.3 ASN Visa/Registration number

The Series is based on these Sporting and Technical Regulations and has been approved by the Deutscher Motor Sport Bund on 01.03.2024 with visa number 211/24.

2.4 Organising Committee and Sporting Committee

2.4.1 Organising Committee

The Organising Committee for the Porsche Mobil 1 Supercup competition at each Series event (unless amended in the relevant event Supplementary Regulations) will be:

- Oliver Schwab, Project Manager Motorsport – Porsche Mobil 1 Supercup, Dr. Ing. h.c. F. Porsche AG
- Valeska Nikola, Organisation – Porsche Mobil 1 Supercup, Dr. Ing. h.c. F. Porsche AG
- Dominik Quosdorf, Technical Support Delegate – Porsche Mobil 1 Supercup, Dr. Ing. h.c. F. Porsche AG

Members of the Organising Committee may delegate functions and responsibilities where appropriate to other employees of Dr. Ing. h.c. F. Porsche AG, and Dr. Ing. h.c. F. Porsche AG may nominate additional members of the Organising Committee where necessary.

The address of the Organising Committee is that of the Series Organiser (see Article 2.1).

2.4.2 Sporting Committee

A Sporting Committee for the Series will be established comprising of the following people or their nominated representatives:

- The Series Organiser;
- The Permanent Race Director;
- The Permanent Chairman of the Stewards;
- The Series Technical Support Delegate.

The role of the Sporting Committee will be to resolve any issues arising in respect of interpretation or application of the Series Sporting, Technical and Environmental Regulations other than those which fall within the exclusive remit of the Officials of the events and will include taking decisions on:

- Any questions concerning points or the classification of the Series;
- Any matters arising from the Series Regulations which are not specific to an individual event.

Decisions taken by the Sporting Committee shall be final and are not subject to protest or appeal.

2.5 List of Permanent Officials

(see also relevant Supplementary Regulations for each event)

- Chairman of the Stewards– Richard Norbury (Motorsport UK 60288)
- Race Director – Peter Roberts (Motorsport UK 140949)

3 Regulations and legal basis of the Series

The Series is governed by the following regulations:

- FIA International Sporting Code (ISC) and its appendices;
- Sporting, Technical and Environmental Regulations of this Series and the DMSB approved modifications and supplements (Bulletins);
- Supplementary Regulations for Series events including modifications and supplements issued by the DMSB or the Stewards of the competition (Bulletins). Where any aspect of the Sporting Regulations must be adapted for a specific event, the provisions of the Supplementary Regulations for that event will take precedence over the Sporting Regulations;
- DMSB Event Regulations;
- DMSB Circuit Rules, except where any special regulations are set out in the rules presented here;
- DMSB Licence Regulations;
- DMSB Legal System and Code of Procedure (RuVO); FIA Judicial and Disciplinary Rules;
- DMSB Decisions and Provisions, DMSB Environmental Guidelines, Anti-Doping Regulations of the National and International Anti-Doping Agency (NADA Code and WADA Code) as well as the Anti- Doping and Anti-Alcohol Regulations of the FIA;
- The “Application for Team Entry” and/or the “Application for Driver Entry” signed by the Competitor/Driver;
- FIA Code of Ethics and DMSB Code of Ethics;
- Other FIA and DMSB regulations as applicable;

3.1 Official language

For these regulations of the Porsche Mobil 1 Supercup only the English text approved by the FIA/DMSB is binding, except for the relating DMSB regulations specified in Art. 3 (Regulations and Legal Basis of the Series), for which only the German language is binding.

In case of interpretation the DMSB jurisdiction is the responsible authority.

The official language of the International Sporting Code is stated within that document.

3.2 Responsibility, changes to the rules of participation and cancellation of an event

- (a) The participants (Competitors, Drivers, car owners, team members, registered keepers and team guests) attend and take part in any Series event at their own risk. They are solely responsible under civil and criminal law for any and all damage caused by them – or for damage to the cars used by them, as far as no exclusion of liability has been concluded.
- (b) The Supplementary Regulations for Series events may only be changed by the ASN of the event. Once the event starts, changes in the form of Bulletins may only be made by the Stewards.
- (c) The Event Organiser and the Series Organiser reserve the right to cancel or relocate an event or individual races, subject to approval by the ASN concerned and the FIA where the calendar is affected. Claims for damages or performance shall be excluded in all such cases.

3.3 Porsche Mobil 1 Supercup Code of Good Conduct

The Porsche Mobil 1 Supercup is a Series characterised by equality of opportunity and fairness in both technical and sporting terms. All those involved in the Series, i.e. participants, officials and organisation, make a significant contribution to how the Series is perceived, both internally and by the general public and to the atmosphere in the Series through their conduct and their communication.

All those involved are responsible for conducting themselves in such a way as to uphold and safeguard in the long term the professionalism that prevails in the Series, as well as the esteem in which the Series and its participants are held within motorsport and by the general public. Moreover, fair and sporting competition represents an important safety aspect for all participants and is intended to minimise the risks involved.

For this reason, all those involved agree to acknowledge the philosophy of the Porsche Mobil 1 Supercup and to comply with the rules of conduct of the Series.

- (a) Both on and off the race track, all those involved will:
- treat all participants, officials and organisers respectfully,
 - follow the laws and the rules of the sport, exemplify and promote fairness together with the rules of conduct,
 - neither express themselves or behave in an insulting, offensive or abusive way, nor tolerate such expressions or modes of conduct, either in direct conversations, interviews, etc. or in other communication, e. g. press releases, posts in social media, etc.
 - always behave in the interests of safety and permanently cooperate in efforts to reduce risks,
 - use resources in a sustainable way, giving priority to the well-being, safety and satisfaction of others before their own personal goal,
 - always comply with the purpose of the sport,
 - inform those who are involved if their conduct is not characterised by fairness, sportsmanship, respect and tolerance,
 - cooperate with all other persons involved so as to develop and improve the Series and its status further on a continuous basis.
 - respect the laws and local customs in the countries visited by the Series.
- (b) Participants who are found to have committed one or more of the following may be excluded by the Series Organiser from the Series or may be suspended or disqualified by the Stewards from taking part in one or more competitions:
- Failed to comply with the rules of good conduct;
 - Breached any of the Regulations;
 - Drawn attention to themselves through unsporting behaviour on or off the track;
 - Expressed themselves or behaved in a disrespectful way towards other participants, officials, organisers, etc.;
 - Ignored the specifications, instructions, meetings of the Series Organisation and/or other official bodies in the context of the organisation and holding of an event;
 - Ignored agreements that had been reached (including between Competitors, teams and Drivers) and did not meet obligations of performance;

- Did not act in the interests of the sport and/or the recognisable objective of undertaking the activities seriously in accordance with the rules that have been acknowledged;
- Brought the Series into disrepute.

Specific mandatory requirements or restrictions in respect of behaviour of participants, or specific conditions of participation, may be published by the Series Organiser in order to minimise the risks of, and maximise protection against, Covid-19 infection.

These will be set out in the Porsche Mobil 1 Supercup Covid-19 Safety Procedures document (the latest version of which will be valid and available from the Series Organiser).

It is essential that these requirements are followed by all participants and any breach of these requirements would be deemed a serious infringement of the Porsche Mobil 1 Supercup Code of Conduct.

Competitors are responsible for ensuring full compliance by every person associated with their entry at all times during every applicable event.

4 Entries and Series Classifications

4.1 Applications/entries, closing dates and acceptance information

4.1.1 Permanent Team Applications

- (a) Application for entry to the Porsche Mobil 1 Supercup must be submitted by a Competitor using the official "Application for Team Entry" form (as supplied by the Series Organiser) and must be received by the Series Organiser no later than 1st March 2024.

If the completed "Application for Team Entry" is received after this date, it may only be considered at the sole discretion of the Series Organiser.

An extension to the number of competition cars of an already accepted application of a Competitor may be considered after the closing date.

- (b) Each individual "Application for Team Entry" by a Competitor must be for a minimum of 2 and maximum of 3 cars. If a team wishes to permanently enter more than 3 cars, the additional car(s) must be entered under a separate Competitor's licence.
Note that entries for a fourth car under the same Competitor licence may only be submitted as a Guest Entry.
- (c) Each Competitor must nominate a representative on the entry form. If a Competitor is unable to be present in person at the competition, he must nominate his representative(s) in writing (text form sufficient) to the Stewards. A person having charge of an entered car during any part of a competition is responsible jointly and severally with the Competitor for ensuring that the requirements are observed.

4.1.2 Permanent and Non-Permanent Driver Applications

- (a) A Competitor may apply for entry of a Permanent Driver or Non-Permanent Drivers for each permanently entered car. Both Permanent Drivers and Non-Permanent Drivers in permanently entered cars are eligible to score points for the Team Classification but only Permanent Drivers are eligible to score points in any Driver Classification.
- (b) Non-Permanent Drivers may only participate with a permanently entered car with a permanent competition number in the Series. An application for a Non-permanent Driver must be submitted for each event individually. A single application for multiple events will not be accepted. This restriction may be removed at the sole discretion of the Series Organiser.
- (c) The official "Application for Driver Entry" form (as supplied by the Series Organiser) for Permanent Drivers must be received by the Series Organiser as a supplement to the "Application for Team Entry" by 15th March 2024. The Series Organiser reserves the absolute right to accept or reject an application for a Permanent Driver that arrives after this time limit. However, if a late application is accepted the Driver will no longer be eligible to score points for the Driver Classification or the Team Classification unless the Series Organiser (at its sole discretion) accepts the delay in submission of the entry as being, exceptionally, a case of force majeure.
- (d) With the submitted "Application for Driver Entry" a Permanent Driver must specifically indicate if he wishes to participate in the ProAm Classification or the Rookie Classification. The "Application for Driver Entry" must be signed by the Driver and the Competitor.
- (e) The official "Application for Driver Entry" form (as supplied by the Series Organiser) for Non-Permanent Drivers must be submitted to the Series Organiser at least 7 calendar days prior to the start of the competition concerned (ISC Art 2.1.7.a refers). The Series Organiser reserves the absolute right to accept or reject an application for a Non-Permanent Driver that arrives after this time limit.
However, if a late application is accepted the Driver will no longer be eligible to score points for the Team Classification unless the Series Organiser (at its sole discretion) accepts the delay in submission of the entry as being, exceptionally, a case of force majeure.
- (f) Non-Permanent Drivers are not eligible to register for either the Rookie or ProAm classifications and therefore may not take part in any podium ceremonies for those classifications.
- (g) The "Application for Driver Entry" must be signed by the Driver and the Competitor.

4.1.3 Guest Team Applications

- (a) The Series Organiser may permit Guest Teams to participate in individual competitions. Guest Teams may take part without being eligible for points for the Team Classification on condition that they comply with the conditions of the Series Regulations and of the Supplementary Regulations for the relevant event.
- (b) Guest Teams should apply for participation in a single competition no later than 28 calendar days prior to the start of the relevant competition (ISC Art 2.1.7.a refers) using an "Application for Team Entry" (as supplied by the Series Organiser).

The Series Organiser reserves the right to accept or reject an "Application for Team Entry" of a Guest Team by a Competitor that arrives after this time limit. There is no automatic entitlement to acceptance or participation in the Series.

- (c) Each individual "Application for Team Entry" of a Guest Team by a Competitor must be for a minimum of 2 and maximum of 3 cars which are only entered for one competition at a time. Exceptions from this regulation are Guest Entries of a permanent Competitor for a third or fourth car which may be submitted under their existing Competitor licence for one event.
- (d) The Series Organiser reserves the right to enter cars under its own "Application for Team Entry" as a VIP Guest Team. The Series Organiser also reserves the right for this VIP Guest Team to enter only a single car.

4.1.4 Guest Driver Applications

- (a) The Series Organiser may permit Guest Drivers to participate in individual competitions. Guest Drivers may take part without being eligible for points for any Driver Classification on condition that they comply with the conditions of the Series Regulations and of the Supplementary Regulations for the relevant event.
- (b) Guest Drivers should apply for participation in single competitions no later than 28 calendar days prior to the start of the relevant competition (ISC Art 2.1.7.a refers) using an "Application for Driver Entry" (as supplied by the Series Organiser). The Series Organiser reserves the right to accept or reject an "Application for Driver Entry" for a Guest Driver that arrives after this time limit.
- (c) Guest Drivers are not eligible to register for either the Rookie or ProAm classifications and therefore may not take part in any podium ceremonies for those classifications.
- (d) Guest Drivers may only participate with a car that is entered for a single competition. If a Guest Driver enters for a second or further competition he may use the same car as before, provided that the car has been entered again for a single competition. Guest Drivers may participate in a car that has been used by a previous Guest Driver with the same or different competition number. A car with an existing permanent competition number may not be used by a Guest Driver.

- (e) The Series Organiser reserves the right to enter a VIP Guest Driver or Drivers under its own "Application for Driver Entry".
- (f) The Series Organiser reserves the right, at its sole discretion, to permit Guest Teams and/or Guest Drivers to participate in the official Season Test(s). If permitted, this will be subject to certain conditions and/or costs which will be specified separately by the Series Organiser. No Guest Teams or Drivers will be permitted at the Season Roll-Out, where there is one, with the sole exception of VIP Guest Drivers entered by the Series Organiser.

4.1.5 Acceptance of Team and Driver Applications

- (a) The Series Organiser reserves the right to refuse any "Application for Team Entry" or "Application for Driver Entry" at its sole discretion, stating the reason. There is no automatic entitlement to acceptance or participation in the Series. Employees of Dr. Ing. h.c. F. Porsche AG and its subsidiaries are not eligible to participate.
- (b) Notwithstanding acceptance of any "Application for Team Entry" and/or "Application for Driver Entry", permission to participate in any Series competition is always subject to the satisfactory completion of the scheduled licence verification procedure at the relevant event.
- (c) The Competitor will receive a written (electronically signed) confirmation if his Team Entry (Permanent Team / Guest Team) has been accepted.
- (d) The Competitor will receive a written (electronically signed) confirmation if his Permanent Driver, Non-Permanent Driver or Guest Driver Entry has been accepted.

In order to meet the deadlines for the receipt of an "Application for Team Entry" or "Application for Driver Entry" the application must be submitted to the Series Organiser fully completed and signed via an electronic system provided by the Series Organiser.

4.2 Driver Classifications of the Series

Only Permanent Drivers who take part in at least six Series classification rounds during the season will be included in any of the final Championship Standings.

4.2.1 Overall Classification

The Overall Classification is the Series classification for all Drivers of the Porsche Mobil 1 Supercup.

4.2.2 ProAm Classification

The ProAm Classification is a separate classification for Drivers without a professional motor racing background.

The minimum age to enter the ProAm Classification is 35 years (the Driver must be at least 35 by the closing date for the submission of entries 15th March 2024). Participation is based on the sporting résumé of a Driver and requires written (electronically signed) approval of the Series Organiser.

For the classification to be contested, a minimum of 5 Drivers must have permanently entered the ProAm Classification. The maximum number of Drivers to participate in the ProAm Classification is limited to 8. The slots will be allocated on a first come first served basis (based upon date of receipt of fully and correctly completed applications).

The points are allocated according to the points system of the Overall Classification.

Within the "Application for Team Entry" to apply for entry to the Series a Competitor must include at least one Driver in the Overall Classification, who cannot enter the ProAm Classification.

Where a Team enters cars under multiple Competitor licences, the Series Organiser reserves the right at its sole discretion to amend this minimum requirement.

4.2.3 Rookie Classification

The Rookie Classification is a separate classification for Drivers participating in their first full season in the Series who have participated in no more than 5 races of the Porsche Mobil 1 Supercup in previous years.

Any Driver who has permanently entered the Series in any previous year, regardless of the number of events in which they actually participated, may not register as a Rookie Driver for the current season.

The maximum age for participation in the Rookie Classification is 25 years (the Driver must not have reached their 26th birthday by the closing date for the submission of entries) 15th March 2024.

4.2.3.1 Rookie Programme

To support Rookie Drivers, the Series Organiser may offer the Porsche Mobil 1 Supercup Rookie Programme, which is an official development programme for young Drivers.

Participation in this programme is optional and must be requested when submitting the "Application for Driver Entry". The number of programme participants is limited to eight and the positions will be allocated on a first come first served basis (based upon date of receipt of fully and correctly completed applications).

To be eligible for participation in the Rookie Programme, the Driver must:

- be a Rookie according to these Sporting Regulations
- have submitted a complete "Application for Driver Entry" as a Permanent Driver with the appropriate entry fee
- agree to take part in at least six competitions
- not be a member of the Porsche Motorsport Junior Programme

To receive the full support of the programme, the Driver must:

- participate in all mandatory programme elements specified by the Series Organiser or its nominated representative
- take part in at least six competitions
- ensure peak physical and medical condition
- comply with the programme's code of conduct

The following events are part of the Rookie Programme and are therefore mandatory for the participants to attend. An individual schedule for each event will be communicated by the Rookie Programme Coach.

- Pre-Season Fitness Check 2024 (Potsdam, 19.03. - 21.03.2024)
- Season Kick-Off Meeting 2024 (Leipzig, 21.03. - 23.03.2024)
- End-of-Season Fitness Check 2024 (Location tbd, date tbd.)

* Subject to amendments.

If any participant fails to participate in any of the mandatory events listed above, the Series Organiser may exclude that individual from the programme and/or disallow their entitlement to receive any prize or other benefit from the programme.

All Competitors and Drivers participating in this programme must agree to provide access to the Cosworth data for data analysis and evaluation as required by the Rookie Programme Coach after each session. The Series Organiser ensures that the provided data will only be used for the specified purpose and no data and/or graphical analysis will be distributed to or shared with other Drivers or teams.

The Rookie Programme will include a scoring system for participants (approved by the Series Organiser and administered by the Rookie Programme Coach) based on a number of factors, including both on-track and off-track participation and performance. The details of the scoring system will be communicated at the Season Kick-Off Meeting and a Rookie Programme winner will be declared at the end of the season.

Participation in the Rookie Programme is not a requirement of eligibility for any Rookie Classification entry, points, prize money or trophy.

The Series Organiser reserves the right, at its sole discretion, to accept a Non-Permanent and/or Guest Driver(s) into any or all elements of the Rookie Programme or to waive specific Rookie criteria.

4.2.4 Porsche Junior

A Porsche Junior is a Driver officially nominated and supported by Dr. Ing. h.c. F. Porsche AG and who has successfully completed the Dr. Ing. h.c. F. Porsche AG selection process.

The Porsche Junior(s) for the 2024 season of the Porsche Mobil 1 Supercup is Alessandro Ghiretti. Only Porsche Juniors are permitted to use the Porsche Junior branding and labels.

Only one Porsche Junior can be registered as a Driver per Competitor, irrespective of the number of team licences and entered cars.

4.3 General Entry Terms & Obligations

4.3.1 Commitment to participate

For the purposes of these Regulations, for a Competitor and/or Driver to be considered to have participated in a Season Roll-Out, Season Test or competition they must have taken part in at least one on-track session at the respective event.

(a) **Competitor obligation**

Upon registration of a Permanent Entry, a Competitor undertakes to participate with each registered car in the official Season Roll-Out (where there is one), all official Season Tests and all competitions of the Series in 2024 without exception.

(b) **Permanent Driver obligation**

Upon registration of a Permanent Driver, the Driver undertakes to participate in at least six competitions of the Series in 2024.

(c) **Failure to participate**

Any Competitor or Driver who fails or anticipates failing to fulfil the above participation requirements must inform the Series Organiser in writing (text form sufficient) at the earliest opportunity and in any event no later than 48 hours before the Season Roll-Out (where there is one) or Season Test (as appropriate) or the start of the relevant competition (ISC Article 2.1.7.a refers), stating any mitigating reasons.

The Series Organiser may request that the Stewards penalise a failure to comply with this deadline. The Series Organiser may at its sole discretion accept a request for non-participation from a Competitor and/or Driver.

Any failure to inform the Series Organiser or to submit any mitigating reasons may automatically be deemed a contravention of these Regulations.

Failure to participate may result in a fine of at least EUR 3,000 per car and/or Driver. The Stewards shall decide whether the Competitor and/or Driver shall be subject to a penalty, taking into consideration if the Series Organiser has previously received and accepted a request for non-participation from the Competitor and/or Driver.

Any Permanent Driver who fails to take part in at least six competitions will not be included in the Overall, ProAm or Rookie final classification for the year.

Drivers ranked behind this Permanent Driver will move up in the final classification accordingly. The final Team Classification will not be adjusted.

Any Permanent Driver who fails to participate in at least six competitions will forfeit any points or prize money awarded in the races in which the Driver participated (no other Driver's scores or prize money will be adjusted).

This may only be waived in exceptional circumstances at the sole discretion of the Series Organiser.

4.3.2 Authorisation

- (a) With the submission of the "Application for Team Entry" or "Application for Driver Entry", Competitors and Drivers authorise the Series Organiser to submit entry forms on their behalf for those events which host races which form part of the Series in 2024. Direct nominations to the promoters by the participants are not permissible.
- (b) The Competitor/Driver agrees that Dr. Ing. h.c. F. Porsche AG, whose representatives constitute the Organising Committee for each Competition, has access to and authority to utilise the reports, data and documents of the Technical Scrutineers at all times.

4.3.3 Driver transfers between teams

Any Driver wishing to transfer from one Competitor to another must complete a new "Application for Driver Entry" form and submit it to the Series Organiser.

A Driver transferring to another Competitor may not use the same competition number, but instead must use either the number of a car already entered by the new Competitor or a new number (allocated by the Series Organiser) if a new car is being entered by the Competitor.

4.3.4 Replacement of cars, engines, gearboxes or engine control units (ECU)

A Competitor may not replace a car that has already been entered and allocated a competition number, unless the car has suffered significant or irreparable damage at a preceding event or during an event or unless the Series Organiser gives approval for other exceptional reasons.

(a) Replacement of cars before or between events

Any change of cars before or between events must be approved in advance by the Series Organiser in writing.

The Competitor must request such a change in writing (electronically signed) prior to the event where the replacement car will be used, using the form provided by the Series Organiser. The Competitor will receive a written confirmation (electronically signed) if the change has been approved.

(b) Replacement of cars during an event

The Competitor must make a written application (using the form provided by the Series Organiser) to the Stewards seeking permission to use a replacement car and it shall be at the sole discretion of the Stewards whether to accept or reject the application.

Where the Stewards accept such an application, that acceptance may be given subject to specific conditions. Where the replacement of a car is accepted after Qualifying it will normally be on condition that the car starts the race from the back of the grid.

(c) Replacement of engine, gearbox or ECU before or between events

Any change of engine, gearbox or ECU before or between events must be approved in advance by the Series Organiser in writing. The Competitor must request such a change in writing (electronically signed), using the form provided by the Series Organiser. The Competitor will receive a written confirmation (electronically signed) if the change has been approved.

(d) Replacement of engine, gearbox or ECU during an event

The Competitor must make a written application (using the form provided by the Series Organiser) to the Stewards seeking permission for any change of engine, gearbox or ECU during an event and it shall be at the sole discretion of the Stewards whether to accept or reject the application.

Where the Stewards accept such an application, that acceptance may be given subject to specific conditions or imposition of a penalty.

4.3.5 Team transporters and transport vehicles

(a) Each Competitor with up to 3 competing cars will be permitted one transporter and awning in accordance with Article 17.1. This must be parked in the Competitor's designated paddock area and may contain an area at the rear specifically for team seating and relaxation.

(b) If a permanent Competitor has a fourth (Guest) Entry, application may be made to the Series Organiser at the time of the original Guest entry submission, for a second transporter and awning to be permitted in the paddock. Approval of such an application will be at the sole discretion of the Series Organiser.

(c) No additional transporter or other vehicle which would require parking space in the event Overflow parking area will be permitted access to the event unless written (text form sufficient) permission has been granted by the Series Organiser.
Requests for such permission must be made no later than 28 calendar days before the start of the competition concerned (ISC Art 2.1.7.a refers) and additional charges may apply for Overflow parking.

4.3.6 Effectiveness of the regulations and ranking

In the event of a conflict between the entry documents and these Regulations, then the current version of these Regulations shall take precedence.

4.4 Entry fees**4.4.1 Entry fee for the season**

The entry fee for the **first two** cars is

until	15 th November 2023	EUR 70,950.00 plus VAT*
-------	--------------------------------	-------------------------

after	15 th November 2023	EUR 79,950.00 plus VAT*
-------	--------------------------------	-------------------------

*Prices do not include the value added tax as effective by law, if applicable.

The entry fee for the first two cars includes the following services

- Participation fee for two race cars for all classification rounds
- Ten 3-day team catering tickets per race event
- 24 support event paddock passes for all race events (per car: 4 permanent pit lane passes, 4 race by race pit lane passes, 4 paddock passes)
- A maximum of five parking tickets for support event parking per race event
- Participation fee for two cars for the official Season Test
- Provision of a pit lane shuttle vehicle (Porsche Cayenne, Macan or Panamera) during the Grand Prix de Monaco for rides in connection with the Porsche Mobil 1 Supercup after signing a corresponding loan agreement. One shuttle vehicle will be provided per Competitor licence.

The entry fee for each further car irrespective if entered as a third car under the Competitor licence of the first two cars or entered under a second or third Competitor licence when submitting the "Application for Team Entry" is

until 15th November 2023 EUR 25,950.00 plus VAT*

after 15th November 2023 EUR 30,250.00 plus VAT*

*Prices do not include the value added tax as effective by law, if applicable.

The entry fee for each further car includes the following services:

- Participation fee for one race car for all classification rounds
- Five 3-day team catering tickets per race event
- 12 support event paddock passes for all race events (4 permanent pit lane passes, 4 race by race pit lane passes, 4 paddock passes)
- A maximum of two parking tickets for support event parking per race event
- Participation fee for one car for the official Season Test

Where further cars are entered under a second or third Competitor licence: provision of one additional team car (Porsche Cayenne, Macan or Panamera) per Competitor licence used during the Grand Prix de Monaco for rides in connection with the Porsche Mobil 1 Supercup after signing a corresponding loan agreement.

The Permanent Team Entry fee will be invoiced, plus value added tax as effective by law, by Dr. Ing. h.c. F. Porsche AG after assessing the "Application for Team Entry".

The invoice is not a confirmation of acceptance of the "Application for Team Entry".

Force majeure, labour disputes, civil disturbances, action by official bodies and other unforeseeable, unavoidable and serious occurrences, in particular restrictions and measures due to the Covid-19 pandemic, shall release the Series Organiser from its duties to perform regarding the aforementioned

scope of services. In case of cancellation of services, the Series Organiser will accordingly try to compensate the cancelled services with other services or refund a reasonable part of the entry fee to the Competitor.

If attendance at any event(s) has to be limited to essential personnel only, it will be necessary to restrict the provision of tickets and passes accordingly. If so, the Series Organiser will notify Competitors of the number of passes which will be made available for the applicable event(s).

4.4.2 Entry fees per competition

The Guest Entry fee per car is

until	30 th January 2024	Single Race Weekend: EUR 6,000 plus VAT* Double Race Weekend: EUR 7,650 plus VAT*
after	30 th January 2024	Single Race Weekend: EUR 7,650 plus VAT* Double Race Weekend: EUR 9,300 plus VAT*

*Prices do not include the value added tax as effective by law, if applicable.

The entry fee per car includes the following services:

- Participation fee for one race car per race event
- Five 3-day team catering tickets per race event
- 12 support event paddock passes per race event (8 race by race pit lane passes, 4 paddock passes)
- A maximum of two parking tickets for support event parking per race event
- Only if a Guest Entry is exceptionally accepted for the Grand Prix de Monaco: provision of a pit lane shuttle vehicle (Porsche Cayenne, Macan or Panamera) during the Grand Prix de Monaco for use in connection with the Porsche Mobil 1 Supercup after signing a corresponding loan agreement. One shuttle vehicle will be provided per competitor licence.

The Guest Entry fee will be invoiced, plus value added tax as effective by law, by Dr. Ing. h.c. F. Porsche AG after assessing the "Application for Team Entry". The invoice is not a confirmation of acceptance of the "Application for Team Entry".

Force majeure, labour disputes, civil disturbances, action by official bodies and other unforeseeable, unavoidable and serious occurrences, in particular restrictions and measures due to the Covid-19 pandemic, shall release the Series Organiser from its duties to perform regarding the aforementioned scope of services. In case of cancellation of services, the Series Organiser will accordingly try to compensate the cancelled services with other services or refund a reasonable part of the entry fee to the Competitor.

If attendance at any event(s) has to be limited to essential personnel only, it will be necessary to restrict the provision of tickets and passes accordingly. If so, the Series Organiser will notify Competitors of the number of passes which will be made available for the applicable event(s).

4.5 Competition numbers

Competition numbers for all Entries are allocated by the Series Organiser and assigned per car for the entire season.

The competition numbers for returning Permanent Competitors will be allocated based on their Team Classification standing of the 2023 season.

New Permanent Competitors or Guest Team Entries joining the season will receive competition numbers according to their date of entry.

Any car previously entered by a Guest Team may retain its competition number if entered again later in the same Series.

The Competitor may choose which of the allocated numbers is assigned to each car.

Once a competition number has been assigned to a car, the number will remain with that car for the remainder of the season and, if a change of chassis is necessary, the number (and corresponding tyre allocation) will be transferred to the new chassis.

The Series Organiser reserves the right, in exceptional circumstances, to reassign allocated competition numbers ahead of the first event.

5 Licences

5.1 Licence requirements

(a) **Drivers**

Drivers must hold a valid International Driver's licence for 2024 issued by an FIA-affiliated ASN, of Grades

- International Licence Grade A (ITA)
- International Licence Grade B (ITB)
- International Licence Grade C-Circuit (ITC-C)

(b) **Competitors**

Competitors wishing to register with the Series must be in possession of a valid International Competitor's licence issued by an FIA-affiliated ASN and have paid the registration fees.

A maximum of four Entries will be accepted under a single Competitor's licence.

(c) **Age regulations**

In compliance with the valid DMSB Licence Regulations and the FIA International Sporting Code, no Driver under 16 years old will be permitted to participate in the Series.

5.2 Conditions for Competitors outside their national territory

DMSB licence holders and licence holders by another ASN affiliated to the FIA have the right for participation and are entitled to score points for the Series.

For every competition foreign Competitors/Drivers must present the written authorisation of their own ASN.

6 Insurance, liability exclusion and disclaimer

6.1 Organiser's/promoter's insurance

The insurance company and policy number will be stated in the Supplementary Regulations for each event.

6.2 Declaration by the Competitor and Driver on the exclusion of liability, disclaimer of the car owner

In accordance with DMSB Event Regulations.

7 Events

7.1 Calendar of events

The 2024 Series consists of 8 races organised as circuit races. At each event there will be one race. However, under exceptional circumstances should a race be cancelled or deferred, then there may be two races at a subsequent event.

Should a venue host more than one Series event on consecutive weekends, each race weekend will be considered a separate event. Should there be more than one race at any event, then each race will be considered a separate competition for the purposes of these regulations. It is the Competitor's responsibility to ensure there are no travel or other restrictions which would affect their participation in any event for which they are entered.

	29.04. – 01.05.2024	Season Test, Silverstone Circuit, Silverstone*
R1	17.05. - 19.05.2024	FORMULA 1 GRAN PREMIO DELL'EMILIA ROMAGNA 2024, Imola
R2	24.05. - 26.05.2024	FORMULA 1 GRAND PRIX DE MONACO 2024, Monte Carlo
R3	28.06. - 30.06.2024	FORMULA 1 GROSSER PREIS VON ÖSTERREICH 2024, Spielberg
R4	05.07. - 07.07.2024	FORMULA 1 BRITISH GRAND PRIX 2024, Silverstone
R5	19.07. – 21.07.2024	FORMULA 1 HUNGARIAN GRAND PRIX 2024, Budapest
R6	26.07. - 28.07.2024	FORMULA 1 BELGIAN GRAND PRIX 2024, Spa-Francorchamps
R7	23.08. - 25.08.2024	FORMULA 1 DUTCH GRAND PRIX 2024, Zandvoort
R8	30.08. - 01.09.2024	FORMULA 1 GRAN PREMIO D'ITALIA 2024, Monza

*Subject to confirmation of commercial agreement

7.2 Maximum number of cars authorised

Subject to the maximum number of permitted cars being defined in the circuit licence, the Series Organiser limits the maximum number of permitted cars for permanently entered starters to 28 and to an overall maximum of 32 including Guest starters.

Entries by the Series Organiser are excluded from the overall limit of 32. By exception and at the sole discretion of the Series Organiser, the maximum number of permitted cars may be increased.

8 Points for Classification

8.1 Awarding of points

The winner of a race is the participant who has driven the specified distance with his car within the shortest time, taking account of all penalties.

The winner of a race regarding the awarding of points is the entered participant driving an entered car on an entered competition number who satisfies the conditions for the awarding of points and who has driven the scheduled distance with his car in the shortest time, taking account of all penalties. All participants who started the race will be classified in accordance with the number of laps of the circuit covered, providing that they have completed at least 75 % of the distance covered by the winner (rounded down to the nearest whole lap). Drivers who have completed the same number of laps will be classified in the order in which they last crossed the control (timing) line.

If the race distance is shortened or stopped and cannot be resumed, the participants will be awarded the points as indicated below, providing that at the time the race is stopped the leader has covered the following distance (based on the laps completed by the winner as shown in the official race results as the basis for the Final Classification):

- If at least 50% of the scheduled number of race laps have been completed (rounded down to the nearest whole lap), 100% points will be awarded.
- If less than 50% of the scheduled number of race laps have been completed (defined as above), 50% points will be awarded.

If a race is stopped before the leader has finished two complete racing laps (and is therefore declared null and void) and cannot be restarted, or a race cannot be started at all, then 50% points will be awarded on the basis of the Qualifying Final Classification. The Stewards may disallow the points awarded to any Driver and/or Competitor who they deem responsible for causing the stoppage of a race which is then declared null and void and cannot be restarted. If there has also been no Qualifying Classification, then no points will be awarded.

The scheduled race distance is the number of laps specified in the Supplementary Regulations for the relevant event. No additional laps are added to the race distance if the Safety Car is used at any time during a race. The warm-up, formation and slow-down laps do not count towards the race distance.

8.1.1 Overall and ProAm Classification

All results of the individual races count towards the Championship Standings at the end of the year, there are no void or 'dropped' results.

The Overall and ProAm Classification are listed separately. The winner of each driver classification is the entered Driver with the highest total number of points of all races.

The winner of the 2024 Series is the entered Driver with the highest total number of points in the Overall Classification from all the races.

For the avoidance of doubt, Drivers will score points according to their places in the final classification of each race; this will be irrespective of whichever classification they are in. Points will be awarded in accordance with the 'Table of Points' as set out in Article 8.2.

Points for the ProAm Classification will be awarded separately using the same 'Table of Points', hence the highest placed ProAm Classification Driver will be awarded 25 points in the ProAm Classification, and so forth.

It is permitted for a Driver to change teams during a season (subject to Article 4.3.3) and to continue scoring points for the Drivers' championship (Overall or ProAm).

Non-Permanent Drivers and Guest Drivers will not be awarded points for the Overall or ProAm Classification but may participate in any podium ceremonies as applicable.

Permanent Drivers classified behind non-eligible Permanent Drivers (according to Article 4.1.2 (c)), Guest Drivers or Non-Permanent Drivers in the race results from an event will move up within the Driver ranking accordingly.

For the purposes of the Championship Standings, non-classified Permanent Drivers will be ranked behind classified Drivers according to their relative positions in the final classification of the respective race.

Where a Permanent Driver is disqualified they will be similarly ranked behind non-classified Drivers.

8.1.2 Team Classification

The Team Classification is independent of the Driver Classification. The points of two cars entered under the same Competitor licence are added for the Team ranking.

Points for the Team Classification are awarded according to the final classification of each race, irrespective of the several classification categories.

If there are more than two cars entered under one Competitor licence, the Competitor must nominate two Drivers (Permanent or Non-Permanent) eligible to score Team points for the corresponding competition in writing before the end of the administrative checks at each event of the Series.

Should the Competitor fail to nominate two Drivers then the two respective Drivers with the lower two competition numbers (the lowest number being 1) will be nominated automatically for that competition by the Series Organiser. No other cars from that Competitor will be considered for the Team Classification.

If a Non-Permanent Driver is nominated to be eligible to score Team points, the Competitor will receive the points in the Team Classification achieved in accordance with the final classification of each race (subject to Article 4.1.2(b)).

Results of Guest Drivers will not count towards the Team Classification of the Series.

Any Driver eligible to score Team Points who is classified behind non-eligible Permanent Drivers (according to Article 4.1.2 (c)), Non-Permanent or Guest Drivers in the race results from an event will move up in the race results accordingly for the purpose of allocating Team points.

8.1.3 Rookie Classification

The Rookie Classification is independent of the Driver and Team rankings. Points for the Rookie Classification will not be awarded separately but will be based upon the points scored in the Overall Classification.

All results of the individual races count towards the Championship Standings at the end of the year, there are no void or 'dropped' results.

The winner of the Rookie Classification is the Driver with the highest total number of points of all races.

8.2 Table of points

Participants who satisfy the conditions for the awarding of points in the Driver (Overall and ProAm Classification) and/or Team ranking for the individual classification rounds shall be allocated the following points in the order in which they are placed in each race, in accordance with the rules for the Driver (Overall and ProAm Classification) and/or Team Classification. *

1st place:	25	points
2nd place:	20	points
3rd place:	17	points
4th place:	14	points
5th place:	12	points
6th place:	10	points
7th place:	9	points
8th place:	8	points
9th place:	7	points
10th place:	6	points
11th place:	5	points
12th place:	4	points
13th place:	3	points
14th place:	2	points
15th place:	1	point
16th place or below	0	points

VIP Guest Drivers entered by the Series Organiser will participate but not be included in any Driver, Team or prize money classification.

(* Note that the rules regarding points scoring in relation to Permanent and Non-Permanent Drivers may mean that the effective classification order for the purposes of points scores for any round may differ between the Drivers and the Teams classifications.)

8.3 Equality of points

If an equal number of points is achieved by more than one Driver, the positions in the Championship Standings at the end of the year are based on the highest number of first place results, then second place results and possibly all further results achieved in the 2024 Series. If, after application of this rule, a tie still exists, the decision is made based on the better results of the final race.

If an equal number of points in the Teams' Classification is achieved by more than one Team, the positions in the final classification are based on the highest Team score (i.e. the points of the two eligible Team scoring cars) in the final race. If a tie still exists, then the highest Team score in the penultimate race will be considered, and so on. Should a tie remain after Team scores from all races have been considered then the higher placed Team will be the Team with the highest placed eligible Team scoring driver in the final race.

8.4 Publication of points

Championship Standings will be published by the Series Organiser in an official Team Information communication after the end of each event.

Should an error in any classification require a correction to be made after publication, this can be done by the Series Organiser. Any questions or complaints concerning the Championship Standings must be submitted in writing (text form sufficient) to the Series Organiser and be received within seven days of the first publication of the Championship Standings concerned.

The points and prizes classifications will be considered final seven days after the end of the last event of the season and, subject only to any ongoing judicial or sporting matters, from that time no further amendments or corrections will be made. In case of any disputes concerning point or prize attributions, these will be decided by the Sporting Committee. Decisions of the Sporting Committee will not be subject to protest or appeal.

9 Title, prize money and trophies

9.1 Title Overall Winner

The Driver who has scored the highest number of points in the Overall Classification after all respective events of the 2024 Series will be awarded the title:

"2024 Porsche Mobil 1 Supercup Champion"

9.2 Prize Money and trophies

9.2.1 Prize Money

The prize money is paid by the Series Organiser exclusively to the Competitors.

9.2.1.1 Overall and ProAm Classifications

Prize money will be awarded in respect of each race (for participants who satisfy all relevant conditions) for classification positions 1 to 15 (Overall Classification) and for classification positions 1 to 5 (ProAm Classification) of each official race result.

Overall Classification

1st place:	EUR	7,000
2nd place:	EUR	5,500
3rd place:	EUR	4,500
4th place:	EUR	4,000
5th place:	EUR	3,500
6th place:	EUR	3,250
7th place:	EUR	3,000
8th place:	EUR	2,750
9th place:	EUR	2,500
10th place:	EUR	2,250
11th place:	EUR	2,000
12th place:	EUR	1,750
13th place:	EUR	1,500
14th place:	EUR	1,250
15th place:	EUR	1,000

ProAm Classification

1st place:	EUR	800
2nd place:	EUR	600
3rd place:	EUR	500
4th place:	EUR	400
5th place:	EUR	300

Any permanently entered Driver who fails to participate in at least 6 competitions will forfeit any prize money awarded in the races in which the Driver participated (no other Driver's prize money will be adjusted). This may only be waived in exceptional circumstances at the sole discretion of the Series Organiser.

Non-Permanent Drivers using a competition number entered in the 2024 Series are entitled to receive prize money.

Guest Drivers entered in the 2024 Series are entitled to receive prize money.

VIP Guest Drivers entered by the Series Organiser are excluded from receiving any prize money. Drivers placed after such VIP Guest Drivers move up the prize money system accordingly.

9.2.1.2 Team and Rookie Driver Classifications

Prize money will be awarded in respect of the Championship Standings after the last competition of the Series (for participants who satisfy all relevant conditions) for classification positions 1 to 8 (Team Classification) and for classification positions 1 to 3 (Rookie Classification).

Team Classification

1st place:	EUR	60,000
2nd place:	EUR	45,000
3rd place:	EUR	30,000
4th place:	EUR	20,000
5th place:	EUR	15,000
6th place:	EUR	12,500
7th place:	EUR	10,000
8th place:	EUR	5,000

Rookie Classification

1st place:	EUR	12,000
2nd place:	EUR	8,000
3rd place:	EUR	5,000

The winner of the Rookie Classification 2024 will additionally receive a prize of EUR 30,000. This additional prize money will only be paid out to the Competitor that enters this Driver in the following season of the Series and if the Driver is classified in that season's final Overall Classification. Otherwise, the winner of the Rookie Classification has no right to receive this prize money.

9.2.1.3 Payment of Prize Money

The prize money will be paid approximately 8 to 10 weeks after the last race of the Series (and in any event not before the end of season awards ceremonies). In each case, the prize money will be paid to the Competitor named in the entry, provided that the Competitor/Driver does not owe outstanding amounts to Dr. Ing. h.c. F. Porsche AG and its subsidiaries, all entry conditions and conditions of participation have been adhered to and no sports disciplinary proceedings are outstanding that could influence the final tally of points.

In case the Competitor receives the prize money in addition to a supporting payment, which is paid for participating with at least one Driver who is a Reigning Champion, the Rookie Champion of the previous year, a Porsche Junior or a Shootout Participant the Parties assume the following VAT treatment to the prize money:

The prize money is paid in return as a consideration by the Series Organiser to the participants for their successful participation. Thus, an exchange of supply and consideration takes place between the Organiser and the participant.

In this case the prize money is paid plus VAT if VAT should arise according to the applicable VAT Law. In order to check if VAT is to be charged as per the applicable VAT Law, the participants confirm their

status as entrepreneurs for VAT purposes by indicating their tax number and respective VAT identification number.

The Participant has to issue invoices, plus VAT if applicable, for the successful participation according to applicable VAT law. Upon request by the Participant and after providing a valid VAT registration number the Organiser will issue a credit note to Participant with regard to the services provided. Any VAT legally due is shown separately on the credit note. The addresses as shown in this Agreement will be used as invoice address.

9.2.2 Prizes in kind

The Series Organiser may also remunerate the Drivers with a prize in kind for their successful participation.

9.2.2.1 Overall Driver Champion

The 2024 Porsche Mobil 1 Supercup Champion will receive a Porsche road car from the standard Porsche model range in addition to the prize money. The handover of the car will take place in Germany at a time and location to be determined by the Series Organiser. The country variant of the car will be German. Model, equipment and specification will be chosen by the Series Organiser depending on availability.

In case the receipt of a prize in kind is considered as a taxable event in the home country of the respective Driver, the Driver is responsible for the taxation of this prize in kind.

9.2.2.2 Rookie Programme Winner

A special prize in kind, a trainee programme for a DMSB-Permit Nordschleife (DPN), will be awarded to the winner of the Porsche Mobil 1 Supercup Rookie Programme (as distinct from the Rookie Classification of the Series). This will be subject to a separate contract, the details of which will be agreed between the Driver and the Series Organiser.

9.2.2.3 Prize for highest number of pole positions

The Driver with the highest number of pole positions (based on the final Starting Grid of each race) from all races will receive a watch. If two Drivers achieve the same number of pole positions, the prize will be awarded to the Driver who achieved that number first.

9.2.2.4 Trophies

Trophies will be awarded by the Series Organiser at each competition to the 1st, 2nd and 3rd classified Drivers in each of the Overall, ProAm and Rookie classifications (where appropriate). Trophies will also be awarded by the Series Organiser at the end of the Series to the 1st, 2nd and 3rd classified Drivers in each of the Overall, ProAm and Rookie classifications (where appropriate) and to the 1st, 2nd and 3rd overall classified Competitors in the Team classification.

9.2.3 Taxation

According to § 50a German Income tax Act (EStG), Competitors, who are not registered in Germany, must currently pay withholding taxes on the remuneration, means the prize money, also team prize money & special prizes and supporting payments.

Dr. Ing. h.c. F. Porsche AG is obliged to withhold income taxes on this remuneration for assignment of property rights (personal rights, image rights and other rights) and for races in Germany. Therefore, remuneration will be split as follows:

- 20% royalties, 15.825% withholding taxes on every race, no matter where performed.
- 80% activity through races, 15.825% withholding taxes if race is performed in Germany. The same applies if a tax deduction is to be made under foreign law.

Because Dr. Ing. h.c. F. Porsche AG is obliged to withhold these taxes on the remuneration, this procedure will also be applied for prizes in kind. As such, for points scored in German races, the winner will have to pay tax based on the value of the prize.

If it is not clear whether the primary tax residence of the Competitor is located in Germany, Dr. Ing. h.c. F. Porsche AG can only renounce on taxation if a location certificate issued by his tax office has been presented.

If in further countries Dr. Ing. h.c. F. Porsche AG has also to withhold income taxes on payments (prize money/ winner car) scored in this country, Dr. Ing. h.c. F. Porsche AG shall be allowed to deduct the respective amounts from any payments to be made. Dr. Ing. h.c. F. Porsche AG will issue a certificate in respect of the tax paid.

In case the Competitor receives prizes in kind in addition to a supporting payment, which is paid for participating with at least one Driver who is a Reigning Champion, the Rookie Champion of the previous year or a Porsche Junior, the Parties assume the following VAT treatment to the prize in kind:

Prizes in kind in its net amount (exclusive of VAT) is the consideration remunerated by the Series Organiser in return for the successful participation of the Driver with the highest number of Overall Classification points (barter transaction according to Sec. 3 Para. 12 sentence 2 German VAT Law). Thus, an exchange of supply and consideration takes place between the Series Organiser and the Driver.

The Driver must indicate if he acts as a non-entrepreneur or an entrepreneur for VAT purposes. If he acts as an entrepreneur for VAT purposes, he must indicate his tax number or VAT identification number.

The Series Organiser issues invoices for the supplied prizes in kind plus VAT, if applicable. In return, the Participant has to issue invoices to the Series Organiser for successful participation according to local VAT law, plus VAT if applicable.

Any applicable VAT shown on the invoices of the Series Organiser for the prizes in kind must be paid by the Driver to the Series Organiser. Upon request by the Participant and after providing a valid VAT registration number the Series Organiser will issue a credit note to Participant with regard to the services provided. Any VAT legally due is shown separately on the credit note. The addresses as shown in this Agreement will be used as invoice address.

10 Private practice and testing

There is no restriction on private practice or testing.

11 Administrative Checks & Meetings

The Competitor and Driver must ensure that all the necessary documents as set out in the organiser's rules of participation are submitted by the correct date and time for licence verification. Failure to comply with this requirement may result in disqualification from the competition. The following documents must be presented by the Driver/Competitor:

- Competitor's licence
- Driver's licence
- Medical certificate of aptitude
- Authorisation to take part in relevant competitions abroad

The requirement for completion of administrative checks and licence verification applies to the Season Roll-Out (where there is one), official Season Test(s) and all race events.

All Competitors and Drivers may be required to submit a signed declaration at each event regarding the validity of their licence and any necessary authority to participate. Where this is required, Competitors will be informed by the Series Organiser and must submit the declaration by the time specified in the Official Timetable for the event.

11.1 Timetable for administrative checks

The times for administrative checks are specified in the Supplementary Regulations and the Official Event Schedule which are available via the Team Information communication or on the Digital Notice Board. Competitors and Drivers must comply with the timetable for administrative checks. Any failure to do so may be reported to the Stewards.

11.2 Drivers' briefing

The time and location of the Drivers' briefing will be published in the Supplementary Regulations of the event. All Drivers, together with their Competitor's Team Manager or other authorised representative, must be present throughout the briefing.

The requirement to attend any scheduled Drivers' briefing applies to all race events and official Season Tests. A Driver may not take part in a race event or a test session until he has attended the respective Drivers' briefing or, where agreed by exception, received a personal briefing from the Race Director.

Any non-attendance or late attendance may result in a fine or other penalty being imposed by the Stewards. Any Driver operating a mobile device (phone, tablet, etc) during the briefing, other than for the purposes of the briefing, will be deemed to be absent and will be referred to the Stewards.

The Drivers' briefing at events may be delivered by way of video conference or by digital presentation with Race Director voice-over which will be made available to teams electronically, along with briefing notes.

In either of these cases, all Competitors and Drivers must submit, by the time specified in the Official Timetable for the event, a signed declaration that they have viewed and understood the presentation. An opportunity will be provided for any questions to be raised with the Race Director and any such questions and answers will be made available to all Competitors and Drivers.

The Season Briefing notes and the event specific notes and presentation material issued by the Race Director are considered formal instructions which must be complied with.

11.3 Team Managers' meeting

The time and location of the Team Managers' meeting is specified in the internal event schedule. This is additionally displayed on the Digital Notice Board. Team Managers' meetings may be held by means of video conference. Participation is mandatory. Any non-attendance or late attendance may incur a penalty.

11.4 Official meetings / press conferences / representation meetings

The time and place for all official meetings, press conferences and representation meetings (autograph session, photoshoots, etc.) are specified in the internal event schedule. Any established non-participation or incomplete participation may incur a fine or other penalty being imposed by the Stewards.

11.5 Notice Board

In accordance with Article 11.9.4 of the FIA International Sporting Code, the Series Organiser's Digital Notice Board will serve as the official medium for announcements. All Competitors, Drivers and Officials will be given appropriate access details.

12 Scrutineering/technical checks

Before and, as required, during or after each competition all cars will be inspected by one or more Technical Scrutineers licenced by an FIA affiliated ASN.

The names of the Scrutineers will be stated in the Supplementary Regulations for the event or in a Stewards' Bulletin. They may be provided by the promoter or by the Series Organiser.

Any car or part of a car can be selected at any time by the Stewards for a further technical examination, including examination outside the event venue.

The Technical Scrutineers are entitled to check any aspects of the cars in competition at any time during the event and may conduct checks without prior request from the Clerk of the Course or the Stewards.

The Technical Scrutineers are responsible for the operation of the Parc Fermé and are the only persons authorised to give instructions in this respect to the Competitors.

Competitors and Drivers shall at all times follow the instructions of the Technical Scrutineers regarding the checking and re-inspection of cars.

12.1 Initial Scrutineering

At each competition, the Competitor must present his car and the Driver must present the compulsory Driver's safety equipment at Technical Scrutineering at the published times. The car must be presented in the configuration as it will be used in the competition (including competition numbers) and it is the Competitor's responsibility to ensure that the car fully complies with the applicable Technical Regulations at all times throughout the competition, commencing with initial scrutineering. The presentation of a car for scrutineering will be deemed an implicit statement of conformity.

The following car documents must be presented with the car to the Technical Scrutineers:

- Technical passport
- Certificate for rollover structure

The cars and Drivers' safety equipment are to be shown to the Technical Scrutineers for technical and visual examination during the stated inspection periods. The inspection periods are to be strictly adhered to.

Once initial technical scrutineering is completed, the cars may only leave the paddock during the event with the permission of the Series Organiser. Any car that is permitted to leave the paddock (other than to go on track) must be presented again to the Technical Scrutineers before taking any further part in the competition. It is the Competitor's responsibility to present the car to the Technical Scrutineers.

No car may take part in a competition until it has successfully passed initial scrutineering checks.

Unless a waiver is granted by the Stewards, Competitors who do not keep to the set time limits will not be permitted to take part in a competition.

12.2 Subsequent Scrutineering

After qualifying and each race, the cars must be brought to the Parc Fermé area by the route described in the Drivers' Briefing. The Parc Fermé area of the Series will be identified in the Supplementary Regulations for each event or in the notes from the Drivers' Briefing. The route from the finish line to the Parc Fermé is subject to the Parc Fermé provisions. All cars must be driven by the relevant Drivers in full racing equipment to the Parc Fermé after each qualifying session and race; this does not apply to the Technical Scrutineers and their assistants or to nominated Drivers for podium cars in accordance with Article 17.5.

All cars are subject to Parc Fermé conditions until the end of the protest period and until released by the Technical Scrutineers or the Stewards. During this time, no works of any kind may be performed on the cars. Once in the designated area, no car may be removed without the permission of the Technical Scrutineer / Stewards. No individual may enter Parc Fermé without the permission of the Technical Scrutineers.

Cars that have been involved in an accident at any time during an event must be presented to the Technical Scrutineers. Any repairs identified by the Technical Scrutineers must be undertaken by the Competitor and the car represented to the Technical Scrutineers. It is the Competitor's responsibility to do so before taking part in the competition again.

The Stewards, Race Director, Clerk of the Course or the Chief Medical Officer can require a Driver to have a medical examination at any time during an event. This examination may include a test for alcohol. Any failure to comply may result in disqualification from the competition.

Any car that is permitted to leave the paddock for repairs after an incident must be presented again to the Technical Scrutineers before taking any further part in the competition. It is the Competitor's responsibility to present the car to the Technical Scrutineers.

It is not permitted to drive the competition cars on public roads at any time during an event, unless specifically defined in the Drivers' Briefing.

The Stewards will publish the results for each car scrutineered. These results will not include any specific figures or data except where a car is found to be in breach of the technical regulations.

13 Running of the competitions

13.1 Pre-Start

The pre-start is the line-up of all cars before entering the circuit for the free practice, qualifying and races.

All cars must be driven from the team awning/pit to the official pre-start by the relevant Driver unless described otherwise in the Drivers' Briefing. All Drivers must be ready for collection with full racing clothing in their team awning/pit at the time defined in the schedule. Should a Competitor or Driver not be ready in time he may forgo the right to take part in the relevant session. The final decision on participation in the session will be taken by the Stewards.

13.2 Practice

One free practice session of up to 45 minutes will be scheduled for each competition.

For the first pre-start of the season, the order of the cars will be determined by a draw. For competitions thereafter, the order of the cars in the pre-start is determined by the classification of the preceding race.

Any Drivers who were not classified in the previous race, will then be placed in the pre-start in the following order:

- 1) Any Driver who participated in the previous race but was not classified.
- 2) Any Driver who participated in the previous race but was disqualified
- 3) Any permanently entered Driver who did not participate in the previous race.
- 4) Any Non-Permanent Drivers.
- 5) Any Guest Drivers.

In each of cases 1-5 above, the Drivers will be placed in the order of their competition numbers. Any Driver who participated in the preceding race but using a different race number will, for these purposes, be considered not to have participated.

All cars and Drivers must be ready in the pre-start area when called forward to proceed to the track. Any car unable to leave the pre-start area and enter the track with the rest of the cars will be given a further minute (60 seconds) after the last car has departed, to leave the pre-start area and proceed to the pit lane. After this time, any car which has not left the pre-start will only be permitted to proceed to the pit lane at the sole discretion of the Race Director.

The free practice session time duration may be reduced in length should it be temporarily stopped for reasons of safety or force majeure.

Should a practice session be stopped for any reason, all cars must reduce speed smoothly and safely to 80 kph and proceed with extreme caution back to the pit lane without overtaking other cars.

The Race Director may, at his sole discretion, authorise the Drivers to increase their speed to facilitate their prompt return to the pit lane.

If two or more cars set identical fastest lap times in practice, the classification order will be based on the order in which those times were set, with the first car to set that time taking precedence, and so on.

During any practice session any Driver who, in the opinion of the Stewards, stops or slows unnecessarily on the circuit or impedes another Driver may receive a penalty. Any Driver causing a practice session to be stopped may be referred to the Stewards and may receive a penalty.

13.3 Qualifying

- (a) One qualifying session will be held at each competition, normally of 30 minutes duration (the precise duration will be announced within the timetable of the respective event). All participants must qualify for the respective race. Admission to the starting grid and the races is dependent on the result of the qualifying session.
- (b) The order of the cars in the pre-start for qualifying is defined by the results of the free practice session of the respective competition. Should unforeseen circumstances force the cancellation

of the free practice session, the pre-start order of the cars for qualifying will be defined by the results of the preceding race as in 13.2 above (for the first pre-start of the season, the order of the cars will be determined by a draw, guest Drivers will be placed at the back in the order of their competition numbers).

All cars and Drivers must be ready in the pre-start area when called forward to proceed to the track. Any car unable to leave the pre-start area and enter the track with the rest of the cars will be given a further minute (60 seconds) after the last car has departed, to leave the pre-start area and proceed to the pit lane. After this time, any car which has not left the pre-start will only be permitted to proceed to the pit lane at the sole discretion of the Race Director.

- (c) At the end of the qualifying session, all cars which participated in the session are subject to the Parc Fermé rules.

If a qualifying session is suspended (red flag) and subsequently resumed then Competitors are permitted to work on their cars. However, if a qualifying session is stopped and not continued then all work must cease and all cars will be under Parc Fermé conditions from the point in time when it is declared that the session will not be resumed.

- (d) A Driver will be admitted to a race by participating in the qualifying session and achieving a qualifying time not exceeding 107% of the fastest Driver in the qualifying session.

No Driver may start a race without having taken part in a qualifying or practice session unless authorised by the Stewards in consultation with the Race Director.

Any Driver failing to meet the qualifying criteria and wishing to participate in the race must make written (text form sufficient) application to the Stewards. Admission of Drivers who have not qualified will be considered by the Stewards in consultation with the Race Director.

If a Driver is unable to set a meaningful lap time in qualifying, one factor which may be considered is whether the Driver set a suitable lap time in the Practice session. However, neither the Stewards nor the Race Director are under any obligation to accept any application from any Driver who has not met the qualifying criteria and their decision in this respect is not subject to protest or appeal.

- (e) Only one qualifying session of up to 30 minutes will take place at any competition with two races.

The participants will qualify for race one with their fastest lap time in the qualifying session and for race two with their second fastest lap time in the qualifying session of the respective competition.

Drivers who do not achieve this qualification may be disqualified from starting. The final decision in this respect will be taken by the Stewards in consultation with the Race Director and their decision will not be subject to protest or appeal.

Should circumstances force the cancellation of the entire qualification session, then the times set in the free practice session will be used to determine the starting grid. At any competition with 2 races, the best free practice time of the Driver in question determines the position on the starting grid for race 1, while the second-best free practice time of the Driver in question determines the position on the starting grid for race 2. Should the qualification session be stopped and cannot be resumed, the following will apply:

- If less than 7 minutes have been completed the session will be deemed null and void and the times set in the free practice session will be used to determine the starting grid (including as above for competitions with 2 races).
- If 7 minutes or more have been completed the qualifying session classification will be used to set the starting grid. Any driver who has not set a lap time in qualifying will be placed behind those cars which have done so, in the order based on their fastest free practice time. For competitions with 2 races this will form the starting grid for race 1. The starting grid for race 2 will be determined by each Driver's second fastest time set in qualifying and any Driver who has not set a second lap time in qualifying will be placed behind those cars which have done so, in the order based on their fastest free practice time.

- (f) Should circumstances force the cancellation of both the free practice session and the qualification session, then the current championship positions at the beginning of the event will be used to determine the starting grid for the race and for the second race where two races are held at a competition.

Any Permanent Drivers with a nil score will be placed in the order of their competition numbers behind those who have a score, with any Non-Permanent Drivers placed behind them in the order of their competition numbers and any Guest Drivers placed at the back in the order of their competition numbers.

For the first competition of the season, the order of the Permanent Drivers will be determined by a draw, with Non-Permanent Drivers placed behind Permanent Drivers in the order of their competition numbers and Guest Drivers placed at the back in the order of their competition numbers.

- (g) If two or more cars set identical fastest lap times in qualifying, the classification order will be based on the order in which those times were set, with the first car to set that time taking precedence, and so on.
- (h) Should a qualifying session be stopped for any reason, all cars must reduce speed smoothly and safely to 80 kph and proceed with extreme caution back to the pit lane without overtaking other cars.

The Race Director may, at his sole discretion, authorise the Drivers to increase their speed to facilitate their prompt return to the pit lane.

- (i) During any qualifying session any Driver who, in the opinion of the Stewards, stops or slows unnecessarily on the circuit or impedes another Driver may receive a penalty. Any Driver causing a qualifying session to be stopped may be referred to the Stewards and may receive a penalty.

13.4 Full Course Yellow

A Full Course Yellow (FCY) procedure may be initiated by the Race Director to neutralise a practice or qualifying session if he considers the circumstances to be appropriate. It will normally be used when double waved yellow flags are needed on any section of track and Drivers or Officials may be in danger, but the circumstances are not such as to warrant the need to stop or suspend the session.

When the order is given in Race Control to initiate a FCY procedure, a message "FULL COURSE YELLOW IN 10 SECONDS" will be sent to all Competitors via the radio system and the timing monitors. Approximately 10 seconds later, a message "FULL COURSE YELLOW NOW" will be sent to all Competitors/Drivers via the radio system and the timing monitors. At the same time, the light panels around the circuit will display "FCY". If appropriate, double waved yellow flags will continue to be displayed at the post prior to the incident.

All cars must reduce speed safely to 80 kph and overtaking, with the following exceptions, is forbidden until the FCY period ends. Overtaking will be permitted under the following circumstances:

- When slowing in pit entry or accelerating in pit exit, cars may be overtaken by other cars continuing on the track at 80 kph;
- A car stopping in its pit lane working area may be overtaken;
- If any car slows with an obvious problem.

The 80 kph speed limit will apply in the pit lane entry and the pit lane exit as well as all around the track. No car may be driven unnecessarily slowly, erratically or in a manner which could be deemed potentially dangerous to other drivers or any other person at any time whilst the FCY procedure is in operation. This will apply whether any such car is being driven on the track, the pit entry, the pit lane or the pit exit.

When the Race Director decides it is safe to end the FCY procedure, the message "FULL COURSE YELLOW ENDING SHORTLY" will be sent via the radio system and the timing monitors. At any time between 10 to 15 seconds later, the "FCY" on the light panels will change to green and all drivers may resume the session as normal. 30 seconds after this the green lights will be extinguished.

13.5 Starting Grid

The starting grid for the race will be determined by the fastest times achieved in qualifying as defined in Article 13.3 and will be formally signed by the Stewards. At competitions with two races the starting grid for race two will be determined by the second fastest times achieved in qualifying as

defined in Article 13.3 and will be formally signed by the Stewards. Should any grid place penalties be applicable, these will be applied in the order in which the relevant offences occurred.

At any competition with two races, should unforeseen circumstances force the cancellation of the 1st scheduled race then the 2nd scheduled race will be run with the relevant qualifying times set for race two.

If one or more Drivers have not set a lap time (for reasons other than cancellation or shortening of the qualifying session) but are given permission by the Stewards to take part in the race, these Drivers will be placed at the end of the starting grid in the following order:

- (a) the Drivers who have started a timed lap from the pit lane, in the order of their best time in free practice;
- (b) the Drivers who have not started a timed lap from the pit lane, in the order of their best time in free practice.

Drivers whose entire lap times were cancelled by decision of the Race Director or the Stewards must, in all cases, start the race behind the aforementioned Drivers at the end of the starting grid. Should more than one Driver have his entire times removed, their starting positions at the back of the grid will be determined by their best time in free practice.

If one or more cars are withdrawn after publication of the starting grid the gaps may be closed up at the discretion of the Stewards. If so, a revised starting grid will be published.

Should the Stewards be required to settle any matter in relation to the starting grid order for any race (or the pre-start order for any practice or qualifying session), their decision in this respect will not be subject to appeal.

13.6 Starting modes

All races will be a standing start with staggered formation (GP start) unless amended by instruction of the Race Director.

13.7 Races

Each race will run over a distance of approximately 70 km. In each case this distance is converted into a certain number of laps for the classification round(s) and indicated in the Supplementary Regulations for the Event.

If the planned distance for the race has not been completed by the leading driver after 30 minutes, the leading Driver will receive the chequered flag the next time he passes the control (timing) line.

If a race is cancelled because of force majeure or for safety reasons, the Series Organiser reserves the right to reduce the number of races in the Series or to designate a replacement event. The Series Organiser is under no obligation to reschedule a race in its original format within an event.

13.8 Start procedure

- (a) The order of the cars in the pre-start is determined by the published starting grid for the relevant race. Cars will be driven from the pre-start area to the pit lane or to the grid using the route described in the Drivers' Briefing.

All cars and Drivers must be ready in the pre-start area when called forward to proceed to the track. Any car unable to leave the pre-start area and enter the track with the rest of the cars will be given a further minute (60 seconds) after the last car has departed, to leave the pre-start area and proceed to the pitlane. After this time, any car which has not left the pre-start area will not be permitted to take up its position on the grid but may start from the pit lane if able to do so and only if a non-track access route allows access to the pit lane.

- (b) Competitors must not place any tape or other forms of marking on the pit wall in order to indicate grid positions to Drivers. Cars must be positioned within their respective grid space marking, with no part of the contact patch of the front tyres outside of the lines (front and sides) at the time of the start signal.
- (c) At circuits where cars are instructed to go directly from the pre-start area to their respective starting positions on the grid, any car which instead enters the pit lane must start the race from the pit lane. Such cars may join the race when the pit exit light is turned to green once all cars on the grid have started the race and have passed the pit lane exit.

At circuits where the cars are instructed to enter the pit lane then complete one full lap before taking up their starting positions on the grid, a 'pit lane open' and 'pit lane closed' time will be given. This is the window when the pit exit will be open for cars to leave the pit lane to go to the grid. If circumstances dictate, the Race Director may, at his discretion, delay, reduce or extend the Pit Exit Open period.

When cars are instructed to enter the pit lane from the pre-start area, they may line up in the fast lane to await the 'pit lane open' time or may go to their pit area, but all cars must leave the pit lane before the pit exit is closed. Any car which has not left the pit lane at the 'pit lane closed' time may start the race from the pit lane if able to do so. Any car which re-enters the pit lane when approaching the grid must start the race from the pit lane. Such cars may join the race when the pit exit light is turned to green once all cars on the grid have started the race and have passed the pit lane exit.

Any car that leaves the pre-start but stops before arriving on the grid and is unable to continue under its own power will be removed to a place of safety. At the sole discretion of the Race Director, it may be recovered to the pit lane. If the car is subsequently able to start the race, it may do so from the pit lane. Such cars may join the race when the pit exit light is turned to green once all cars on the grid have started the race and have passed the pit lane exit.

- (d) Any car starting the race from the pit lane for any reason will not be permitted to take part in the Formation Lap.

- (e) It is permitted for teams to use sunshades whilst on the grid, to cool the car and the driver. All such devices must be removed by the time of the 3-minute signal.
- (f) On display of the 3-minute signal and/or audible signal, all competition cars must be standing on their wheels on the track and must not be lifted again. All personnel must leave the grid and, with the exception of one mechanic per car, must be fully clear of the grid by the time the 1-minute signal is given.
On display of the 1-minute signal and/or audible signal, the remaining mechanics must leave the grid and must be fully clear of the grid by the time the 15-seconds signal is given, taking all equipment with them.
- (g) At the end of the count down, all cars on the starting grid will begin the Formation Lap. Cars in the pit lane are not permitted to participate in the Formation Lap. There will be one Formation Lap prior to each race unless, under exceptional circumstances, the Race Director instructs two or more Formation Laps.

If a car cannot start the Formation Lap, the Driver must make himself known by means such as flashing the headlights, waving his arm etc. If the Driver is able to start the car and leaves the starting grid under his own power before he has been overtaken by the last competing car, then the Driver must not overtake any cars but must maintain position during the Formation Lap. At the end of the Formation Lap, the Driver may resume his original starting position on the grid.

If the car is started under its own power and then joins the Formation Lap after the last car has passed, then the driver must remain at the back of the starting field and take up the last starting position. The vacant space on the grid must not be made up by other cars.

If a car cannot start under its own power, then it will be pushed into the pit lane by the marshals. If the driver can then start the car, he must wait in the pit lane until the race has started and may join the race when the pit exit light is turned to green once all cars on the grid have started the race and have passed the pit lane exit.

- (h) At the end of the Formation Lap, all cars shall promptly take up their grid positions. Once stopped in their grid positions, cars may subsequently not move forward, backward or outside of that position until the race start signal is given.

The Starter will use the Formula 1 light sequence to start the race.

If a Driver has a problem on the grid after the Formation Lap then he must make this known to the Starter, by means such as flashing the headlights, waving his arm, etc. If the Starter decides to delay the start, the yellow flashing lights will be switched on. Then the green lights will be illuminated, and Drivers must complete a further Formation Lap. The Driver that caused the delayed start will be pushed into the pit lane and will, if able, become a pit lane starter. The race distance will be reduced by 1 lap each time this occurs.

13.9 False Starts

Should a Driver be in an incorrect position on the grid or move forward, backward or outside of his grid position before the race start signal is given (red lights out), this may be recorded as a 'False Start' and be referred to the Stewards.

The Race Director and/or Stewards may use any video or electronic means to assist them in reaching a decision regarding false starts.

13.10 Stopping or suspending a race

After the signal to stop the race has been given, all cars able to do so must reduce speed smoothly and safely to 80 kph and proceed directly but with extreme caution to the grid or to another position as directed by the Race Director.

The Race Director may, at his sole discretion, authorise the Drivers to increase their speed to facilitate their prompt return to the grid or to another position.

If a race is stopped before the leading car has finished 2 complete racing laps, the following rules will apply:

- The start will be declared a "No Contest", however penalties may be imposed for any breaches of the regulations during the aborted/stopped race and at the discretion of the Stewards (e.g. where the breach has affected another competitor) these may be applied to the restarted race.
- If all cars are directed to the grid, cars may be worked on only if they enter the pit lane or are already in the pit lane at the time of the red flag. Any car already in the pit lane or entering the pit lane after the red flag may start the race from the pit lane after all cars have started the race and have passed the pit lane exit.
- If all cars are directed into the pit lane when the red flag is shown, they must line up in the outer (fast) lane. Cars may only be worked on if they go to their own pit area. Any car which goes to its own pit area will be permitted to start the race from the pit lane when the pit exit light is turned to green after all cars which remained in the outer (fast) lane have started the race and have passed the pit lane exit.
- Retired Competitors unable to take part in the restart of the race in their original car will be classified as non-starters.
- All Drivers having taken the original start shall be eligible for the restart in their original car (subject to judicial procedures).
- The length of the restarted race will be the scheduled race distance less at least two laps – the revised distance will be defined by the Race Director in consultation with the Stewards.
- The grid for the restart will be the original starting grid.
- Empty starting places on the grid, caused by Drivers unable to restart or starting from the pit lane, will not be filled. Empty starting rows will be filled by moving up.
- Refuelling is prohibited.
- The Race Director may decide that the restart will take place behind the Safety Car for operational or safety reasons, in which case this may commence from the pit lane if all cars were directed there.

If a race is suspended after the leading car has finished two complete racing laps, the race shall be deemed to be in two parts, the first of which finished when the leading car crossed the control (timing) line for the penultimate time before the red flag was shown.

- The length of the second part will be the original race distance less the number of laps completed by the leader before the red flag was shown in part one and less two further laps.
- The grid for the second part will be a standard grid with the cars arranged in the order in which they finished the first part. Gaps on the grid will be made up.
- The Race Director may decide that the second part of the race will start behind the Safety Car for operational or safety reasons, in which case this may commence from the pit lane if all cars were directed there.
- The countdown for the start of the second part will commence with the 5-minute signal unless the Race Director decides otherwise.
- Only cars which took part in the first start will be eligible and then only if they returned to the grid or pit lane under their own power by an authorised route.
- No spare cars or reserves will be eligible.
- Refuelling is prohibited.
- If all cars are directed to the grid, cars may be worked on only if they enter the pit lane or are already in the pit lane at the time of the red flag. Any car already in the pit lane or entering the pit lane after the red flag may start the race from the pit lane when the pit exit light is turned to green after all cars on the grid have started the race and have passed the pit lane exit.
- If all cars are directed into the pit lane when the red flag is shown, they must line up in the outer (fast) lane. Cars may only be worked on if they go to their own pit area. Any car which goes to its own pit area will be permitted to start the second part of the race from the pit lane when the pit exit light is turned to green after all cars which remained in the outer (fast) lane have started the race and have passed the pit lane exit.
- The classification of the race will be the order of finishing of the second part.

If a race is stopped after the leader has completed more than 50% of the scheduled racing laps (rounded down to the next whole lap) then, at the Race Director's sole discretion, the race may not be restarted.

If a race is stopped before either the full distance or time has been achieved and the race is not restarted, then the results will be declared on the basis of the classification order when the leading car crossed the control (timing) line for the penultimate time before the race was stopped.

Any Driver causing a race to be stopped or suspended may be reported to the Stewards and may be subject to penalty up to disqualification from the race.

13.11 Change of weather conditions

- (a) For all sessions, the Teams and Drivers are free to choose slick tyres or wet-weather tyres at any time.
- (b) At the start of a race, once the cars have left their Team area and taken position in the pre-start, the pit crew equipment and tyre trolleys will go from the paddock into the pit lane.
- (c) If there is a change in weather conditions prior to the start of a race, the following may apply:

- (i) During the pre-start procedure
 - i. The Race Director will confirm where tyres may be changed and the procedure for doing so.
 - ii. The normal start procedure will then begin from the 5-minute signal. If the weather conditions continue the Race Director may elect to start the race behind the Safety Car.
 - (ii) During the start process (on the grid) before the formation lap
 - i. The Drivers will be shown the Start Delayed board.
 - ii. The Race Director will decide where Teams may change tyres and issue instructions accordingly.
 - iii. The normal start procedure will then begin from the 5-minute signal. If the weather conditions continue the Race Director may elect to start the race behind the Safety Car.
 - (iii) During the Formation Lap
 - i. The start will be aborted.
 - ii. The Race Director will decide where Teams may change tyres and issue instructions accordingly.
 - iii. The normal start procedure will then begin from the 5-minute signal. If the weather conditions continue the Race Director may elect to start the race behind the Safety Car.
- (d) If the start or re-start of the race is made behind the Safety Car due to the weather conditions, then the use of wet-weather tyres is compulsory until the Safety Car has returned to the Pits. The start or re-start may be from the pit lane.
- (e) A race will not be stopped in the event of rain or adverse weather conditions unless the circuit is blocked, or the Race Director considers it unsafe to continue.

13.12 Safety Car

The Safety Car will be deployed under the instruction of the Race Director to neutralise a race. This will be deployed in accordance with Article 2.10 of Appendix H to the FIA International Sporting Code, varied only in respect of the flag signals shown at the end of the intervention period and the pit lane exit lights, both of which will follow Formula 1 Safety Car procedures as detailed below. For the first lap of each race the Safety Car will be positioned before the last corner unless notified otherwise by the Race Director. If the start/finish straight is completely blocked, an electronic arrow board or sign will indicate that cars should follow the Safety Car through the pits.

The Safety Car procedure will be that firstly waved yellow flags with stationary 'SC' boards will be displayed around the circuit. All cars must slow down immediately – overtaking is prohibited. The Safety Car will then be deployed to pick up the leader and all cars must remain no more than 5 car lengths apart. The green light at pit lane exit will remain on at all times. Any car entering the pit lane and subsequently rejoining the track whilst the Safety Car and the line of cars following it are passing the pit lane exit must merge safely into the line of cars on track in accordance with their relative positions at the second Safety Car Line.

Once the Race Director is satisfied that racing may resume, the Safety Car lights will normally be switched off at the timing line Sector 2 (refer to the event circuit map) and, in accordance with Formula 1 procedures, all 'SC' boards will be withdrawn but yellow flags will continue to be displayed. As the Safety Car enters the pit lane, a green flag will be displayed at the control (timing) line, to signify the resumption of the race and at this time all yellow flags will be withdrawn. Should the Safety Car enter the pit lane during the last lap of the race then the yellow flags will continue to be displayed at the marshals' posts and cars will take the chequered flag on track as normal without overtaking.

Once the Safety Car has returned to the pit lane, a Driver is not permitted to overtake or overlap another car until his car has reached the control (timing) line.

13.13 Finish

- (a) The end-of-race signal will be given at the Control Line as soon as the leading car has covered the full scheduled race distance or next crosses the Control Line having completed the maximum race time.
- (b) Should for any reason (other than when a race is aborted or suspended in accordance with Article 13.10) the end-of-race signal be given before the leading car completes the scheduled number of laps, or before the prescribed time has been completed, the race will be deemed to have finished when the leading car last crossed the Control Line before the signal was given. Should the end-of-race signal be delayed for any reason, the race will be deemed to have finished when it should have finished.
- (c) After receiving the end-of-race signal all cars must proceed on the Circuit directly to the Parc Fermé without stopping and without any assistance (except that of the marshals, if necessary).
- (d) Any classified car which cannot reach the Parc Fermé under its own power will be placed under the exclusive control of the marshals who will take the car to the Parc Fermé.
- (e) The control (timing) line applies both to the track and to the pit lane, except for the end of the race where a Driver must take the chequered flag on the track in order to be classified for that lap.

14 Protests, Right of Review and appeals

The FIA International Sporting Code is applicable for protests and appeals, together with DMSB Event Regulations and the DMSB Legal System and Code of Procedure as well the FIA Judicial and Disciplinary Rules for FIA appeals.

Protest deposit - payable to the DMSB:	International status	EUR 500
Appeal deposit – payable to the DMSB:	International status	EUR 1,500
Right of Review deposit – payable to the DMSB (acc. 14.1.1 ISC):	International status	EUR 1,500

Appeal to the FIA – payable to the FIA: EUR 6,000

(Protest and appeal deposits are exempt from VAT)

The Series Organiser shall be entitled to be party to any appeal.

In accordance with Article 15.1.4 of the FIA International Sporting Code, the Series is registered with the FIA by the DMSB which is the competent sporting tribunal for appeals.

In accordance with Article 12.3.4 of the FIA International Sporting Code, certain decisions are not subject to appeal. No appeal may be made against any element of decisions resulting in the application of the following penalties applied by the Stewards or the Race Director:

- (a) "Drive-through" or "Stop-and-Go" penalties including those imposed during the last laps of a race (or after the race) and converted to a time penalty.
- (b) Penalties stating or implying the cancellation of a number of practice or qualifying lap times.
- (c) Penalties stating or implying a drop of grid positions for the race.
- (d) Time penalties added to the Driver's elapsed race time (either during or after the race)
- (e) Imposition of Reprimands or penalty points.
- (f) Obligation for a Driver to start a race from the pit lane.
- (g) Fines imposed for breaches of Part 3: Environmental Regulations

In addition, should the Stewards be required to settle any matter in relation to qualifying criteria or the starting grid order for any race (or the pre-start order for any practice or qualifying session), their decision in this respect will not be subject to appeal.

Should a "Notice of Intention to appeal" be submitted to the Stewards, Competitors should note the provisions of Article 15.5.2 of the FIA International Sporting Code regarding the immediate liability for payment of the appeal deposit, even where the declared intention is not subsequently followed up.

Where Stewards' Decisions are delivered by e-mail or other electronic or digital means (such as the Digital Notice Board) then any appeal period shall commence at the time at which the Decision e-mail is sent or the time at which the Decision is posted on the Digital Notice Board, whichever is the earliest in time.

15 Choice of Law, Exclusion of jurisdiction of a court and limitation of liability

- (a) Subject to prevailing sporting regulations, these Regulations for the Porsche Mobil 1 Supercup shall be governed by the law of the Federal Republic of Germany.
- (b) The jurisdiction of a court is excluded for decisions of the FIA, the DMSB, their jurisdictions, the Stewards, the Race Director, the Series Organiser as judge in terms of § 661 German Civil Code.

- (c) No claim for compensation of whatever kind may be derived from actions and decisions of the DMSB or its jurisdiction as well as of DMSB representatives or the Series Organiser, except in the case of a damage caused on purpose or by gross negligence, except for damage or harm to life, body or health resulting from the deliberate or negligent breach of duty, including a legal representative or agents of the group of persons released from liability, and except for any other damage resulting from the deliberate or grossly negligent breach of duty, including a legal representative or agent of the group of persons released from liability.
- (d) Implied exclusions from liability shall remain unaffected by the above exclusion of liability clause.

16 TV rights/advertising and television rights

All copyright, sound and picture rights lie with Formula One World Championship Limited (FOWC), including the pictures which are adopted by television broadcasts in the 2024 Series. All television rights of the 2024 Series, including terrestrial broadcast as well as cable and satellite television broadcast, all video rights and all rights on the use of the complete electronic media, including internet, lie with Formula One World Championship Limited (FOWC). Any kind of recording, broadcast, repetition or reproduction for commercial purpose, particularly also distribution via social media platforms, without written agreement of the Formula One World Championship Limited (FOWC) is prohibited and can lead to high claims for compensation.

The Series Organiser is entitled to use exclusively all rights of the Competitors, Teams and their Drivers, particularly names, logos, team equipment and cars, for the production of interactive games of the Series and to assign the rights to a third party for this purpose.

The media recorded by the on-board cameras in each car, as referred to in Article 2.10.5 of the Technical Regulations, is the sole property of FOWC who have granted permission to the Series Organiser for this media to be used solely by the Technical Manager, the Stewards and the Race Director for the purposes of safety, technical and judicial inquiries. The media may be shown to relevant Competitors' representatives or Drivers as part of any safety, technical or judicial inquiry but is not permitted to be copied, filmed, photographed or otherwise replicated in any form to any person. The media will normally be erased after each session at an event.

17 Specific Regulations

17.1 Paddock

- (a) The image of the Series and the participating Teams must be to a professional standard at all times. This includes, for example, team clothing, articulated lorries, awnings, pit walls and antistatic floor coverings (the use of carpet flooring is not permitted).

- (b) Each Team is required to provide an articulated lorry with a working awning in accordance with the FIA standard (maximum width: 8 metres; maximum length: max. articulated car length excluding the tractor unit).
Teams must also provide appropriate means of ensuring that awnings are secured robustly against weather/wind conditions and ensure these are maintained throughout each event.
- (c) In exceptional cases, the Series Organiser reserves the right to permit the length of the awning to include the length of the tractor unit as well. This needs to be considered when planning for the awnings.
- (d) Prior to making any change to the on-site set up and working appearance a Competitor must submit a written (text form sufficient) request to, and receive approval from, the Series Organiser a minimum of 14 calendar days prior to the start of the competition concerned (ISC Art 2.1.7.a refers).
- (e) At least two competition cars must be accommodated in each working awning. Particular attention must be paid to the set-up requirements in Attachment 9.
- (f) Every Competitor must ensure that all safety relevant aspects of its team's working processes are fulfilled and observed.
- (g) Should a Competitor have an exceptional need to bring an additional truck to an event, they must seek prior approval from the Series Organiser. Such approval will be subject to paddock space capacity, will be at the sole discretion of the Series Organiser and may be dependent on payment of an additional fee.
- (h) Only the Team trucks shall have access to the Series paddock. Small trucks and trailers shall only have access to the Series paddock for the purposes of loading and unloading during the official set-up and dismantling periods and all such vehicles must be approved in advance by the Series Organiser. Passenger cars, motorhomes and other vehicles are strictly forbidden and shall not have access to the Series paddock at any time. Unless decided otherwise by the Series Organiser, it is permitted to start dismantling the paddock after the Formula 1 race has started. The precise times for set up and dismantling of the paddock will be specified in the relevant Official Event Schedule. These times must be strictly adhered to.
- (i) All trucks must be washed and cleaned before they are parked in the paddock.
- (j) The use of trucks and trailer roofs as well as lifting platforms as spectator platforms is prohibited.
- (k) With the exception of Porsche Team Catering, all other kinds of catering are prohibited in the paddock of the Series. No separate hospitality or entertaining structures will be permitted by Competitors/Drivers within the paddock.

- (l) As part of all Formula 1 race meetings, catering for guests is available exclusively in the Formula One Paddock Club or in the team catering area provided by the Series Organiser. Tickets can be purchased through the Series Organiser. Should attendance at any event(s) be restricted to essential personnel only, there will be no provision for guest catering at that event(s), either in the Formula One Paddock Club or the Porsche Mobil 1 Supercup team catering area.
- (m) Teams may use their trailers, including the roof, for advertising, respecting at all times the requirements of Article 1.9 of the Technical Regulations. The Series Organiser retains the right, at its sole discretion, to instruct the removal of any advertising or branding that is deemed offensive or inappropriate or in the event that Formula 1 imposes any restrictions on such advertising.

17.2 Pit lane allocation

Teams will be allocated a working area in the pit lane, normally in front of the Formula 1 team garages. Using the Team Classification order at the end of the 2023 Series to establish priority, each Team may request a Formula 1 team garage to work in front of for the season. Guest Teams will be allocated a working area by the Series Organiser. The Series Organiser reserves the right, in exceptional circumstances, to reassign pit lane allocations at its sole discretion.

17.3 Instructions of the Series Organiser and Officials

Instructions of the Series Organiser, their personnel and nominated event Officials must be followed at all times. In the event of failure of any Competitor, Team, Team member, Driver, guest or other individual to comply with these regulations, the Series Organiser will notify the Stewards who may impose a penalty including a fine of at least EUR 500 and up to disqualification from the competition.

17.4 Publication obligation

The nationality of the issuing licence authority must be stated for publications and podium ceremonies.

17.5 Podium ceremony

During the entire podium ceremony, except for the time during which the national anthems are being played, the Drivers on the podium must wear the caps of the tyre manufacturer on their heads with the logo at the front. No political or otherwise inappropriate statements, signals, gestures or stances may be given or displayed by Drivers either leading up to or during the podium ceremony. The ceremony starts with ascending the podium and ends with leaving the podium after the group pictures for the press.

Any violation of this regulation will be penalised with a financial penalty of at least EUR 2,500 by the Stewards. The payment of the financial penalty does not preclude any further penalty.

Competitors must nominate a Team member in respect of each of their cars who will return that car from the pit lane to Parc Fermé should its Driver be required to participate in any podium ceremony. The names of the Team members nominated for each car must be notified to the Series Organiser at licence verification. The car of the overall race winner will be returned from the pit lane to Parc Fermé by a driver nominated by the Series Organiser and published in a Stewards' Bulletin. Competitors are reminded that these cars remain under Parc Fermé conditions throughout this exercise.

It is mandatory for the winner of the Grand Prix de Monaco to attend the Awards Dinner of the ACM together with his Team Manager or the official Team Representative. All Team Managers/Representatives and Drivers participating in the event must bring semi-formal attire (suit, shirt, tie etc.) to the event.

It is mandatory for the winners of all Series awards to attend the end of season Porsche Mobil 1 Supercup awards and the Porsche Night of Champions ceremonies. Any breach of these requirements will incur a financial penalty of at least EUR 2,500 which will be levied by the Series Organiser in respect of each individual award absentee unless explicit agreement has been given for their absence. Such agreement will only be given in exceptional circumstances.

17.6 Stewards' Inquiries

The Stewards may hold inquiries into incidents observed by them or referred to them by the Race Director, Technical Scrutineers, Series Organiser or other parties. The Stewards may seek evidence from any source they choose – in the case of incidents on track the Race Director shall present any video and/or telemetry evidence available and at any time requested by the Stewards, including during inquiries with Competitors and Drivers. Drivers attending Stewards' inquiries must always be accompanied by an authorised representative of the relevant Competitor.

17.7 Incidents

- (a) The Race Director may report any on-track incident or suspected breach of these Sporting Regulations or the FIA International Sporting Code (an "Incident") to the Stewards. After review it shall be at the discretion of the Stewards to decide whether or not to proceed with an investigation. The Stewards may also investigate an incident noted by themselves. Any incidents involving more than one car may be investigated immediately or reviewed after the relevant session or race.
- (b) It shall be at the discretion of the Stewards to decide if any Driver involved in an incident should be penalised. Unless it is clear to the Stewards that a Driver was wholly or predominantly responsible for an incident no penalty will be imposed. If an incident is under investigation by the Stewards a message informing all Competitors which Driver or Drivers are involved will be displayed on the timing monitors (if the facilities at the circuit so permit). However, failure to display notification that an incident has been placed under investigation will not invalidate that investigation or any subsequent decision and/or penalty.

- (c) If a Driver is involved in an incident he may not leave the circuit without the consent of the Stewards. If they consider that circumstances so dictate, the Stewards may instruct that no driver may leave the circuit without their consent.

17.8 Penalties

- (a) At the individual events the Stewards (and the Race Director where specified in these regulations, further to Article 11.10.4 of the FIA International Sporting Code) are responsible for imposing any penalties on the participants in respect of any breach of regulations. Any case not provided for in the regulations will be studied by the Stewards who alone have the power to make decisions, in accordance with Article 11.9 of the FIA International Sporting Code.
- (b) If any special examinations or investigations are required and ultimately lead to a determination of non-compliance with the regulations and/or a penalty being imposed by the Stewards, then the costs of such examinations or investigations shall be met by the Competitor whose car is determined to be non-compliant and/or who is subject to such penalty.
- (c) The fact that penalties have been imposed by the Stewards does not rule out more extensive penalties being imposed by the relevant ASN or the FIA. These disciplinary bodies shall also be entitled to disallow points won in races in the 2024 Series competitions.
- (d) Should any Competitor or Driver have points disallowed, no other Competitor's or Driver's score shall be adjusted as a consequence.
- (e) In the case of disqualification from a competition, the points gained and the prize money for the relevant race(s) shall be forfeited. In the event of disqualification from participating further in the Series, all points and prize money won up to that point shall be forfeited (no other Competitor's or Driver's points or prize money will be adjusted).
- (f) The Stewards may impose any penalty they consider appropriate for a breach of the regulations, up to disqualification from the competition. The Stewards may also decide to impose a suspension for one or more competitions of the Series. Attachment 10 contains a set of guideline penalties that will be taken into consideration by the Stewards, but each case will be considered on its own merits.
- (g) The Stewards may impose penalty points, in addition to any penalty they impose, in relation to any breach of the regulations concerning driving standards, except that penalty points will not be imposed in any case where a Reprimand is imposed. These penalty points shall apply solely to the Porsche Mobil 1 Supercup Series. Should the Stewards impose penalty points upon a Driver which take the Driver's total points to twelve or more, then the Stewards will impose a further penalty that the Driver must start the next Series race in which he participates from the back of the grid. When such a penalty has been served, 12 penalty points will then be removed from the Driver's total.

- (h) Any Driver who accrues three Reprimands for breaches of regulations relating to driving standards will, upon imposition of the third Reprimand, be given a drop of 5 grid positions for the next Series race in which he participates. This will be repeated each time a Driver accrues a further three such Reprimands.
- (i) Should the Stewards decide to impose either a Drive-Through or a Stop-and-Go penalty, the following procedure will be followed:
- i. The Stewards will give notification of the penalty which has been imposed to the Competitor concerned by means of a message on the timing monitors. The Race Director will also announce the penalty to the Driver through the radio system.
 - ii. From the time the Stewards' decision is notified on the timing monitors the relevant Driver may cross the control (timing) line on the track no more than twice before entering the pit lane. In the case of a Drive-Through penalty the Driver must proceed down the pit lane and re-join the race without stopping. In the case of a Stop-and-Go penalty, the Driver must stop in the designated area where they shall remain for the prescribed stop time.

Unless notified otherwise by a Stewards' Bulletin for a particular event, the designated area for Stop-and-Go penalties to be served will be in the respective Competitor's pit lane working area. Competitors are responsible for ensuring that their car stops for the prescribed stop time, and this will be checked by the Timekeepers. When the prescribed stop time has elapsed, the Driver may re-join the race. However, unless the Driver was already in the pit entry for the purpose of serving a Drive-Through or Stop-and-Go penalty, they may not carry out the penalty while the Safety Car has been deployed. The number of times the Driver crosses the control line behind the Safety Car will be added to the maximum number of times they may cross the control line on the track.

Whilst a car is stationary in the pit lane as a result of incurring a Stop-and-Go penalty it may not be worked on. However, if the engine stops it may be started after the prescribed stop time has elapsed.

- iii. Should either a Drive-Through or Stop-and-Go penalty be imposed and notified during the last five laps/ten minutes or after the end of the race, or cannot be imposed for operational reasons, then at the discretion of the Stewards the procedure at ii. above may not apply and the penalty may be converted to a time penalty of 30 seconds in the case of a Drive-Through penalty or 35 seconds plus any prescribed stop time in the case of a Stop-and-Go penalty (unless different conversion times are specified in a Stewards' Bulletin at an event) which will be added to the elapsed time of the car concerned.
- iv. For any breach of the regulations during free practice, the Stewards may (as an alternative to or in addition to any other penalty) impose a Stop-and-Go penalty which they may order to be taken at the start of the Qualifying practice session, in which case

the car concerned may not leave its pit lane working area at the start of the Qualifying session until the prescribed stop time has elapsed.

- v. Any breach or failure to comply with the above procedure may result in the car being disqualified.
- (j) Should the Stewards impose a drop of grid positions on a Driver for a future race, the penalty remains with the Driver even if the Driver moves to another team and/or car. Any drop of grid positions will only be applied in so far as it possible to do so at the applicable race (i.e. if a driver is moved to the back of the grid, any further positions to be dropped will not be carried forward to a further race).
- (k) In accordance with Article 12.8.3 of the FIA International Sporting Code, any fines imposed by the Stewards are payable within 48 hours of their notification to DMSB (the Parent ASN of the International Series).

The DMSB bank account for payment of fines by bank transfer is:

DMSB e.V.

Deutsche Bank Frankfurt

BIC (Swift Code) DEUTDEFFXXX

IBAN DE34 5007 0010 0092 3037 00

- (l) Where a fine is imposed, continued participation in the Series beyond the event at which the fine was imposed may not be permitted until any fine imposed is paid in full.

17.9 The track

Drivers must use the track at all times and may not leave the track without a justifiable reason. For the avoidance of doubt:

- (a) The white lines defining the edge of the track are considered to be part of the track.
- (b) A Driver will be judged to have left the track if all four wheels of the car go beyond the white line or any other designated point where the white line does not exist
- (c) Any kerbs installed beyond the white lines are not considered to be part of the track.
- (d) Any report made by a duly appointed Judge of Fact regarding a Driver having left the track may not be contested by the Competitor or the Driver concerned and a Judge's statement of fact must be accepted as a fact unless later corrected by him or over-ruled by the Stewards. The Race Director and/or the Stewards may, at their sole discretion, review any report for the purposes of ensuring accuracy and consistency. This does not preclude the Stewards from exercising their right to over-rule, or accept a correction from, a Judge of Fact.

The following penalties may be applied:

Practice

- (a) Any Driver identified by a Judge of Fact as having left the track (unless for reasons beyond his control) may have that lap time (and where appropriate the following lap time) deleted by the Race Director or Stewards.

- (b) Any Driver who repeatedly leaves the track may be reported to the Stewards who may impose a penalty. It is not a condition that the Driver must have been shown the Black and White flag or received a warning by radio from the Race Director before a penalty is applied.

Qualifying

- (a) Any Driver identified by a Judge of Fact as having left the track (unless for reasons beyond his control) may have that lap time (and where appropriate the following lap time) deleted by the Race Director or Stewards.
- (b) Any Driver who repeatedly leaves the track may be reported to the Stewards who may impose a penalty up to and including the deletion of all lap times or a drop of grid positions for the race. It is not a condition that the Driver must have been shown the Black and White flag or received a warning by radio from the Race Director before a penalty is applied.

Race

- (a) Any driver identified by a Judge of Fact as having left the track (unless for reasons beyond his control) on a number of occasions will be shown the Black & White flag as a warning.
- (b) Any Driver who repeatedly leaves the track may be reported to the Stewards who may impose a penalty, the minimum being a race time penalty of 5 seconds. Further offences may result in further penalties. It is not a condition that the driver must have been shown the Black and White flag or received a radio warning from the Race Director before a penalty is applied.

At the absolute discretion of the Race Director, a driver may be given the opportunity to give back the whole of any advantage he gained by leaving the track.

18 Safety

18.1 Extrication exercise

At each event, the Series Organiser, in conjunction with the event medical personnel, may elect to hold an Extrication Exercise. The Series Organiser shall, by rotation, nominate a Team and Driver to take part in the exercise. The Team and Driver must comply with this request and have the nominated car and Driver, with all racing equipment, available at the designated date and time in the Series paddock, in full race condition. Failure to comply with this regulation may result in a penalty. The Series Organiser, the Race Director or the Chief Medical Officer, at their sole discretion, may elect to replace the Driver with a member of the medical team undertaking the exercise.

18.2 Pit lane safety

- (a) The maximum speed in the pit lane during practice, qualifying and each race is 60 kph (unless otherwise specified in the Drivers' Briefing) and will be monitored by the relevant Officials. Drivers exceeding the permitted maximum speed during free practice or qualifying sessions may be penalised, including by Stop-and-Go penalties during either of those sessions or a drop of grid positions for the race. Drivers who repeatedly exceed the permitted maximum speed in the pit lane during free practice and/or qualifying may face additional penalties for

speed limit violation. Penalties including a Drive-Through or Stop-and-Go may be issued if the permitted maximum speed in the pit lane is exceeded during a race.

- (b) The use of safety stands (securing the car from dropping unintentionally from the air jacks) for any type of work underneath the car will be strictly enforced. This applies for any operation requiring any part of a team member's body to be under any part of the car (e.g. hands or arms under the wheel arch) with the sole exception of removing or mounting wheels. Any non-compliance will be reported to the Stewards and penalised at the full discretion of the Stewards. Engines must not be running while a car is on jacks or other temporary supports.
- (c) All work on cars in the pit lane must only be undertaken in the Competitor's own allocated working area in the inner (working) lane. No work may be undertaken in the outer (fast) lane or elsewhere in the inner (working) lane. When cars are waiting in the outer (fast) lane prior to exiting the pit lane at the start or restart of any practice or qualifying session or race, no work of any description may be undertaken on the car. It is permitted to use a forced air blower to cool the Driver but any such cooling equipment must be removed from the outer (fast) lane before the pit lane open signal is given.
- (d) The outer (fast) lane is to be kept unobstructed to allow safe passage of cars at all times. It is the responsibility of each Competitor to release their car from the working area only when it is safe to do so. Cars in the fast lane have priority over those leaving the working lane. Cars may not be released from the working area in an unsafe condition.
- (e) Unless instructed otherwise by the Race Director, during all practice and qualifying sessions cars must be parked at an angle of 45 degrees, nose in towards pit garages, whenever they are stopped in the Team's pit area. When a car is ready to leave its pit area, the car must be pushed backwards (not reversed under its own power) with a team member responsible for ensuring the car is released safely and without impeding other cars.
- (f) The onus shall be on all Drivers to take due care and drive within the pit lane speed limit. Drivers must respect the designated pit entry and must not cross the white line at pit exit, details of which will be provided in the Drivers' Briefing.
- (g) All equipment must be kept in a safe position towards garages as soon as cars leave their pit areas at the start of and during practice, qualifying and races.
- (h) No equipment may be positioned on top of the pit wall or any adjacent structure, unless it is firmly secured in position.
- (i) Competitors, team members and Drivers are responsible for the conduct and safety of their guests in the pit lane area. Guests must carry the correct credentials at all times. Any guest found in the pit lane without the correct pass will be excluded from the pit lane and the Competitor will be reported to the Stewards. No person under the age of 16 is permitted in the pit lane at any time.

- (j) Competitors, team members and Drivers must ensure that their guests always respect the pit lane regulations and be vigilant at all times. To this end, it is the responsibility of each Competitor and/or Driver to give a briefing to each individual guest regarding pit lane safety.
- (k) Competitors, team members and guests must wear closed footwear in the pit lane at all times, open footwear is not permitted. It is strongly advised that long trousers (not shorts) are worn by team members. Competitors are responsible for informing their guests of suitable clothing standards when in the pit lane, including footwear and a recommendation for long trousers (all genders) together with covered shoulders.

18.3 General safety

- (a) Drivers are strictly forbidden to drive their cars in the opposite direction to the specified direction unless this is necessary in order to move the car from a dangerous position. A car may only be pushed to remove it from a dangerous position as directed by the marshals. No car may be reversed in the pit lane under its own power.
- (b) At any time whilst on track, Drivers may only use the track and must always observe the provisions of the International Sporting Code and these regulations relating to driving conduct on circuits.
- (c) Official instructions will be given to Drivers by means of the signals set out in Appendix H of the FIA International Sporting Code. Competitors are responsible for observing and complying with these at all times.
At circuits where flag signals are supplemented by light panels/signals, both means of signalling will be deemed to have regulatory value. In case of conflicting signals between the flags displayed by marshals and the light panels/signals, drivers must comply with the requirements of the signal with the highest level of safety.
In order of precedence this means: Red Flag, Safety Car, Double Yellow Flag, Single Yellow Flag, Green Flag.
- (d) If a car stops during any session or race it must be removed from the track as quickly as possible so that its presence does not constitute a danger or hinder other Competitors. If the Driver is unable to drive the car from a dangerous position, it shall be the duty of the marshals to help; however, if any mechanical assistance is required to move the car then the car will not be permitted to re-join. A Driver who abandons a car must leave the steering wheel in place and the car in neutral (unless instructed otherwise by the Race Director or marshals).
- (e) Any driver entering a gravel trap and then re-joining must avoid bringing gravel onto the track and particularly onto the racing line. Any driver ignoring this instruction may be referred to the Stewards.
In practice and qualifying, any car that drives through and out of a gravel trap must go directly to the pits to be checked before continuing the session. In the race, an instruction will be issued by Race Control if a car must pit to be checked.

In all cases when leaving a gravel trap, a driver must re-enter the track offline and avoid depositing gravel on the racing line.

- (f) A car's lights must be illuminated at all times when it is running on treaded tyres and/or the "lights on" board has been shown. The Technical Scrutineers may check the lights at any time until 15 minutes before the green flag. Should any lights fail during the session, no penalty will be imposed but the Race Director may stop a car using the black and orange flag if he considers this is causing an immediate safety issue.
- (g) Should any session or race run into dusk or darkness all cars must, on the Race Director's instruction, have two front headlights and two rear red lights illuminated. Should any lights fail during the session, no penalty will be imposed but the Race Director may stop a car using the black and orange flag if he considers this is causing an immediate safety issue.
- (h) Throughout all sessions there will be a green/red light at the pit exit. Cars may only leave the pit lane when the green light is on.
- (i) Any Driver intending to leave the track or to go to his pit or the paddock area must signal his intention to do so in good time making sure that he can do this without danger.
- (j) In the Drivers Briefing, the Race Director may define a time and place where practice starts will be permitted. It is forbidden to undertake a practice start at any other time or place, or if practice starts have not been authorised.
- (k) At the end of any session or race, each driver may cross the Control (Timing) Line only once before leaving the track
- (l) Team personnel are not permitted to ride on the tyre trolleys or on buggies (or similar vehicles) apart from using the specific seats provided with the vehicle.
- (m) All Drivers must complete and pass all sections of the Edubreak e-learning test provided by the DMSB and administered by the Series Organiser. The final test must be taken under observed conditions. An E-Mail link will be provided by the Series Organiser. The Competitor must ensure that each Driver has completed the test under observed conditions in 2024 before taking part in the Driver's first competition of the Series.
- (n) Only small two- and four-wheeled motorised paddock vehicles may be used within the paddock and must be authorised by the Series Organiser prior to use. These vehicles may only be used when driven by a current full road traffic licence holder and for race team related business. Recreational use is strictly prohibited. Private cars and vans are not considered as paddock vehicles.
- (o) The speed limit in the paddock at each venue is 10 kph.

- (p) Tailgates on transporters must remain closed at all times except when loading and/or unloading at the beginning and end of each event.
- (q) All personnel working on set-up or dismantling of the paddock area must wear high-visibility clothing.
- (r) All paddock vehicles that require personnel to be on the roof (i.e. to affix awnings or flag poles/ flags) must have the relevant safety equipment fitted. Any personnel on the roof must wear the relevant safety harnesses which must be affixed to the equipment on the roof.

Part 2: Technical Regulations

1 Technical Series Regulations

1.1 Summary of the eligible groups/classes

The Porsche Mobil 1 Supercup is a one-make Series with no group/class classification.

Only technically identical cars of the model Porsche 911 GT3 Cup, type 992 (a special series produced by Dr. Ing. h.c. F. Porsche AG), of the model year 2021, 2022, 2023, 2024 and which fully comply with these Regulations are eligible to participate.

The cars must meet the technical specifications of these Regulations and Appendix J of the FIA International Sporting Code in full and must possess a valid and registered DMSB car pass or the corresponding document of another ASN associated to the FIA.

Cars may only deviate from the Technical Regulations where specifically agreed for development purposes on behalf of the Series Organiser. The deviations shall be referred for approval to the Scrutineers by the Series Organiser before the car is used and shall not involve any safety-critical modifications nor may they provide any performance or competitive advantage. Where required by the Series Organiser, Competitors must comply with the fitting of any additional parts or systems for development purposes.

1.2 Principles of the Technical Regulations

In accordance with:

- Articles 251 and 277 (Group EII-SH) of Appendix J to the FIA International Sporting Code
- General provisions, definitions and clarifications regarding the technical rules (DMSB Manual, blue part), see also Article 1.10 concerning safety equipment in events abroad
- These Technical Regulations
- Technical Manuals of the eligible cars
- Technical Information of Dr. Ing. h.c. F. Porsche AG
- Software Information of Dr. Ing. h.c. F. Porsche AG
- Spare Parts Catalogues of the eligible cars

Competitors must comply with all elements of each of the above unless they are clearly specified as being optional.

National regulations of the DMSB deviating from the FIA safety regulations are not valid for series and events with the status International. The safety regulations according to Article 1.10 of these regulations apply.

Should there be any discrepancy between the provisions of these Technical Regulations and any relevant Technical Manual, Technical Information, Software Information or Spare Parts Catalogue, then these Technical Regulations will take precedence.

Any requirements specified in a Technical Manual, Technical Information, Software Information and/or Spare Parts Catalogue may be updated by Dr. Ing. h.c. F. Porsche AG. For Software Information, only the latest version is valid but Setups (based on the latest version) may be varied within the parameters allowed by Dr. Ing. h.c. F. Porsche AG. Any requirements may be varied for any specific competition by means of a Stewards' Bulletin issued at that event.

It is recognised that spare parts listed in the Spare Parts Catalogue may be subject to a change of part number during the season. Therefore a spare part which is identical to that shown in the Spare Parts Catalogue (and which has the same function, working principle and location in the vehicle) but which bears a different part number may be used, subject to prior approval by Dr. Ing. h.c. F. Porsche AG Aftersales Department. Such approval shall be at the sole discretion of Dr. Ing. h.c. F. Porsche AG and it is the responsibility of the Competitor to ensure such approval, where granted, is documented and retained for inspection by the Technical Scrutineers. Where a different part number is solely due to a change of number by the manufacturer for the same part, the new part number may be used without the need to obtain prior approval until such time as the Spare Parts Catalogue is updated. Where part numbers are particular to a model year but those parts are interchangeable between different model years and provide the same function, then the part numbers may be used in any type 992 Cup car independently of the model year (noting that, where parts form a set, they must be used as a set and it is prohibited in such cases to mix parts of an older version with parts of a newer version).

Certain alternative parts as detailed in Attachment 11 which have different part numbers to, but the same function as, the original part in the car or in the Spare Parts Catalogue are permitted to be used for the originally intended function and in the originally intended position.

1.3 General/preamble

Everything that is not expressly permitted in these Regulations is prohibited. Any addition or removal of material, heat treatment or coating to alter the properties of a part or component and/or its dimensions is forbidden. Mounting a part in a different way or location than the original delivery condition is forbidden. All nuts and bolts must be fully tightened (i.e. they must be tightened to the full extent possible using the whole of the available thread) at all times unless specifically stated otherwise within these regulations. Permitted modifications must not result in any illegal modifications or infringements of the Regulations. Any permitted changes may only serve the intended purpose. The decision of the Sporting Committee shall be final regarding any interpretation of these Regulations. The Series Organiser reserves the right to amend and extend these Regulations (in consultation with the DMSB).

The installation of any permitted optional parts or systems must be in accordance with the manufacturer's instructions and must be approved by the Technical Scrutineers. Any such installations remain the sole responsibility of the participant. At the Technical Scrutineers discretion, any Competitor must, if requested, remove any optional part or system.

1.4 Permitted modifications and installations

The only work which is permitted to be carried out on the cars is that necessary for its normal servicing, or for the replacement of parts worn through use or accident.

The limits of the modifications and installations permitted are specified hereinafter. Any part worn through use or accident may only be replaced by identical Porsche Genuine Parts that are assigned to the eligible cars in compliance with Article 2.1. The Porsche Genuine Parts are specified in the valid Spare Parts Catalogue in each case.

The use of components manufactured by Dr. Ing. h.c. F. Porsche AG for other groups of cars (e.g. Porsche road cars) is also prohibited.

The use of any items described as "optional" in the Spare Parts Catalogue is prohibited, if their use is not specifically permitted by these technical regulations.

Throughout the car, the standard fastening components such as nuts, bolts, washers, lock washers, spring washers and split pins must only be replaced by Porsche Genuine Parts.

The service and replacement intervals and adjustment values specified by Dr. Ing. h.c. F. Porsche AG (see Technical Manual) are to be observed.

The Series Organiser may permit modifications that do not correspond to the series production status on all or individual cars, providing these do not confer any competitive advantage (e.g. for the attachment of cameras; radio installations, etc.). The Competitor must make written (text form sufficient) application to the Series Organiser and receive written (text form sufficient) authorisation before making any such modification.

1.5 Driver equipment

Driver equipment must be worn correctly at all times whilst the Driver is seated in the car in the pre-start area, the pit lane or on the track. It is compulsory to wear overalls in compliance with the FIA 8856-2000 or FIA 8856-2018 standard as well as underwear (with long sleeves and legs), balaclava, socks, shoes and gloves in compliance with FIA Regulations.

Furthermore, wearing a helmet in compliance with the FIA Regulations (Appendix L of the ISC) is compulsory.

All Driver equipment must be worn in accordance with the manufacturer's instructions (balaclavas inside race suits, FHR systems correctly secured, etc). Failure to do so may result in the Driver being shown the black flag and/or being ordered by the Race Director or the Stewards to immediately rectify any error or omission and/or any penalty at the discretion of the Stewards.

1.5.1 Frontal Head Restraint System (FHR; HANS® or comparable system)

The use of an FIA-approved head restraint in compliance with FIA list No. 29 is compulsory for all races and competitions within the Series.

Responsibility for ensuring compatibility of the Driver's equipment in order to enable use of such a system and installation of same in the car in compliance with the manufacturer's instructions lies solely with the participant. The relevant manufacturer's certificate is to be presented during Technical Scrutineering.

1.5.2 Drinking system

A drinking system may be used. Installation needs to be fixed using metal hardware and be able withstand a crash of 30G.

1.5.3 Cooling system

A driver cooling system with cooling vest may be used. Installation needs to be fixed using metal hardware on the auxiliary weight base plate and be able withstand a crash of 30G.

1.6 Minimum weights and ballast

It is the Competitor's responsibility to ensure that at all times during a competition the mandatory minimum combined weight of the car with empty fuel tank, Driver equalisation weight and the Driver (together with all compulsory Driver equipment) is reached. At no time during a competition is the car weight permitted to be less than the mandatory minimum weight when the car is either presented for technical scrutineering, is on the track or in Parc Fermé.

The mandatory combined minimum car and Driver weight (together with all compulsory Driver equipment and equalisation weight) will be announced by Stewards' Bulletin at the end of Technical Scrutineering of the first event.

The minimum weight must also be observed when the levels of operating liquids are under minimum level.

The checking of the weights of the cars and Drivers will be conducted on the "official scale" which will be located in the Series Technical Scrutineering tent or in an alternative designated place. This is also the weighing area. In addition, Drivers may be weighed on a separate weighing scale either in the weighing area or in the pitlane.

The "official scale" and any other driver weighing scale will be checked annually and calibrated by the certificated Dr. Ing. h.c. F. Porsche AG Testing Laboratory or any other officially certificated Testing Laboratory.

1.6.1 Base plate auxiliary weight

If the original base plate does not contain the necessary holes for the mounting positions as indicated in these regulations, they can be added after consultation with the Technical Scrutineers. The mounting holes can only be added in the necessary positions to satisfy the requirements of these regulations.

1.6.2 Ballast

The installation of original Dr. Ing. h.c. F. Porsche AG ballast weights is permitted on the auxiliary weight base plate at the position of the passenger's seat in accordance with the illustration in Attachment 3.

The ballast weights are identified by spare part numbers in the Spare Parts Catalogue and the reference table in Attachment 11. No other ballast weights or locations are permitted.

1.6.3 Minimum car weight

The minimum weight of a car will be announced by Stewards' Bulletin at the end of Technical Scrutineering of the first event. The minimum weight of a car consists of:

- the weight of the car with empty fuel tank;
- the weight of the onboard camera (surveillance camera and/or official TV camera), the radio system assigned by the Series Organiser or the weight of the respective substitute ballast;
- the installed additional weights (excluding driver equalisation weight).
- the weight of any additional parts or systems required by the Series Organiser to be fitted for development purposes in accordance with Article 1.1.

1.6.4 Minimum Driver weight

The minimum weight of a Driver will be announced by Stewards' Bulletin at the end of Technical Scrutineering of the first event. The minimum Driver weight consists of:

- the Driver;
- the compulsory personal equipment of the driver (Article 1.5),
- the Driver equalisation weight if applicable.

It is the Competitor's responsibility to ensure that the sum of the installed equalisation weight plus the Driver's actual weight (including his compulsory personal equipment) achieves or exceeds the minimum weight at all times.

1.6.5 Determining the total weight of the Driver and car

The Technical Scrutineers may in their absolute discretion decide to weigh the car and driver separately or in combination.

If the car and the driver (together with all compulsory Driver equipment) are weighed in combination, the weight plus 2.0 kg of weighing tolerance shall be added and the total shall be referenced against the mandatory minimum combined weight, which must be reached.

If the car and the Driver (together with all compulsory Driver equipment) are weighed separately on the official scale and/or Driver weighing scale, the two weights plus 2.0 kg of weighing tolerance for the car and 0.5 kg of weighing tolerance for the Driver weight shall be added and the total shall be referenced against the mandatory minimum combined weight, which must be reached.

Prior to weighing a car, the Technical Scrutineers shall remove the remaining fuel from the fuel tank, after taking a fuel sample.

1.6.6 Weight changes during qualifying and races

During any qualifying session and race, the weight of the car is only permitted to be altered by:

- Changing from slick tyres to wet tyres or vice versa;
- Consumption of consumable materials and fluids.

On the way from the circuit to the Parc Fermé and in the Parc Fermé itself, and on the way to the post-race technical scrutineering, under no circumstances is weight in any form permitted to be added to the car or the Driver.

1.6.7 Verification of the minimum weights by the participants on the official scale

Competitors have the opportunity to check the weight of their cars and Drivers during the event on the official scale and/or Driver scales with the permission of the Technical Scrutineers. Only the measurements recorded by the Technical Scrutineers shall be deemed accurate for the purposes of compliance with the regulations.

1.6.8 Personal protective driver equipment during weighing

During the weighing, each driver must wear and/or carry his complete Driver apparel as set out in Appendix L, Chapter III of the ISC, including the mandatory head restraint system.

1.6.9 Weighing of cars

The cars are weighed as follows:

- Weighing of cars is carried out regularly on the official scale.
- During the free practice and qualifying, weighing can also be done by the Technical Scrutineers on the scale of the FIA, which is at a fixed location in the pit lane. Any differences between these scales are taken into account by the Technical Scrutineers. If the weighing on the FIA scale indicates that the car in question might be found underweight on the official scale, this car, the Driver and his compulsory protective equipment must again be weighed on the official scale which is the only result to be taken into consideration and to be binding.
- If a Driver is given the signal that his car has been selected for weighing, he must take the shortest route possible to the weighing area/FIA scale and turn off the engine.
- The Driver or a team member will receive notification of the measured weights. During weighing the Driver is not permitted in any way to influence the weighing result.

If a car cannot reach the weighing area under its own power, it must be brought to the weighing area solely by marshals. If this is not possible, then the Technical Scrutineers can assign other persons for this purpose.

1.6.10 Leaving the weighing area

Without the consent of the Technical Scrutineers, the Driver is not permitted to leave the weighing area and the car is not permitted to be removed.

1.6.11 Weighing after breakdown and car remaining on circuit during free practice, qualifying and race

If a car breaks down during the free practice, qualifying or race and the Driver leaves his car, he must go directly to the weighing area to determine his weight.

1.6.12 Determining the Driver weights

After every free practice, qualifying and race, all Drivers must go immediately and in any event within 20 minutes of the end of the session (unless amended in the Drivers' Briefing notes) on a direct route from the Paddock/Parc Fermé to the weighing area to determine their weight. Drivers who are approached by the TV partner for an interview may interrupt their walk to the weighing area for the duration of the interview. Drivers who go to the podium are permitted to be weighed on the FIA scale and/or Driver scale. Any differences between the FIA scale and the official scale are taken into account. Drivers who do not go directly to the weighing area to be weighed will be reported to the Stewards. The Stewards will take the final decision regarding any penalty.

The Drivers will be weighed individually. Once the Driver leaves the weighing area, this will be deemed implicit acceptance of the recorded weight. Any appeal against the observed weight must be immediately submitted to the Technical Scrutineers.

1.6.13 Replacement and loss of car parts and car damage

All car parts that were replaced during any session (free practice, qualifying or race) must be presented to the Technical Scrutineers without request for inspection. The parts that were removed from the car will be marked by the Technical Scrutineers if necessary and are not permitted to be modified in any way afterwards. These parts must remain in the pit or in the technical scrutineering tent in sight of the Technical Scrutineers or their assistants until released by the Technical Scrutineers. These parts can be considered when determining the weight instead of the replacement parts.

In case of a loss of coolant caused by damage or an incident during a session, it may be possible to determine the final weight of the car by draining all remaining coolant liquid (from engine, coolant reservoir, all radiators, all coolant hoses and connectors) and adding 24.0 kg to the measured weight of the car. The decision to do so is at the sole discretion of the Technical Scrutineers.

Should a car be presented for weighing with lost or damaged parts it shall be at the sole discretion of the Technical Scrutineers to determine which, if any, parts should be replaced prior to the car being weighed.

1.6.14 Parc Fermé rules for car weighing

Cars that have been specified for weighing are subject to Parc Fermé regulations. It is forbidden to add or remove any substance to/from the car after it has been selected to be weighed. The same applies during the weighing process and after the end of the race. Excluded are actions of the Technical Scrutineers.

It is the Competitor's responsibility to ensure that the car entered by him can be brought directly to the weighing area when instructed by the Stewards or the Technical Scrutineers at any time during

the event. In any case, Parc Fermé rules apply to the car from the moment of the order until the termination of the weighing process.

1.6.15 Weighing in below the minimum weight

If, during any post session weighing procedure, the combination of car and Driver (including compulsory Driver equipment) is found to be below the currently applicable minimum weight, the car will immediately be weighed for a second and a third time on the same scales and in the same condition after the same session and with the same measuring method.

The maximum value of the 3 weights recorded is regarded as the actual weight for the combination of car and Driver (including compulsory Driver equipment).

Falling below the minimum weight during the practice or qualifying session may be penalised with the deletion of the practice or qualification times achieved by the Driver concerned. If the qualification times are deleted, the Driver may be permitted to start the race from the last place on the starting grid, subject to the Stewards being satisfied with regard to the 107% qualifying requirement.

Falling below the minimum weight in the race may result in disqualification from the race classification.

1.6.16 Regulations on the route to and in the weighing area

Parc Fermé rules apply to the route to the weighing area and in the weighing area itself. In addition to the Technical Scrutineers, only the responsible sporting marshals and their helpers are permitted to enter the weighing area. In this area, the only activities on the car are those expressly permitted by the aforementioned persons. If a car is not presented for weighing despite a request, the Technical Scrutineers will inform the Stewards.

1.7 Emissions regulations

The cars must be equipped with a catalytic converter as supplied by Dr. Ing. h.c. F. Porsche AG and in accordance with the DMSB exhaust gas emission regulations.

1.8 Noise regulations

The maximum permitted noise limits are 144 dB (A) measured in compliance with the LWA-procedure and 112 dB (A) in compliance with LP-procedure.

The noise level will be determined in compliance with the DMSB-pass-by measuring method (mandatory for all circuit events)

The current DMSB-noise regulations (see DMSB Manual, blue part) must be respected.

1.9 Advertising and partnerships

The current FIA/DMSB prescriptions for competition numbers and for advertising on the Driver's equipment/on the car (see DMSB Manual, blue part) must be respected. The provisions set out under Article 16 of Part 1 Sporting Regulations also apply.

Under consideration of the FIA/DMSB prescriptions for competition numbers and advertising on cars, the following advertising is compulsory on the car (see Attachment 2):

1.9.1 Series Advertising and Competition Numbers

- (a) The advertising decals, logos, Drivers' names, competition numbers and national identification markings as specified by the Series Organiser, must be affixed to all competing cars during all free practice, qualifying sessions and races of the Series. The size, type, quantity and positioning are determined and announced in the "2024 Sticker Regulations". The registered Competitors will be informed about their competition numbers before the first race. The competition numbers remain the same for all races.

The obligatory badges as specified by the Series Organiser, must be affixed to Drivers' racing overalls during all free practice, qualifying sessions and races of the Series. The size, type, quantity and positioning are determined and announced in the "2024 Badge Regulations".

The "Badge Regulations 2024" and the "Sticker Regulations 2024" are part of these Regulations (see Attachments 1 and 2). Any breach of these Regulations may result in disqualification from the competition.

- (b) All advertising surfaces that are not occupied as specified in the Sticker Regulations are available for the Competitors' own advertising labels. The clearance between such advertising and the mandatory labels and competition number shall be a minimum of 30 mm.
- (c) Cars of a team with virtually identical liveries must have clearly different mirror and rear wing lateral end plate colouring. The colours used on mirrors and rear wing lateral end plates to identify the cars are to be retained for the entire season.

The Competitor is responsible for ensuring that the stickers on the entered cars comply with the applicable legal regulations.

IMPORTANT: Any variations of the FIA/DMSB Regulations are subject to a special waiver issued by the DMSB.

1.9.2 Partnerships

- (a) Competitors must not advertise any partnerships/sponsorship with companies who are either in competition to Dr. Ing. h.c. F. Porsche AG, its parent or partner companies, the official Series partners of Dr. Ing. h.c. F. Porsche AG or who are involved in a legal dispute with Dr. Ing. h.c. F. Porsche AG or a company associated with Dr. Ing. h.c. F. Porsche AG. The Competitors are therefore obliged to notify potential partnerships/sponsorship to Dr. Ing. h.c. F. Porsche AG in advance. Dr. Ing. h.c. F. Porsche AG is entitled to prohibit Competitors from advertising any partnership if the potential partner falls into one of the above two categories.
- (b) The use of advertisements for companies, their products, services or brands that are competitor products, services or brands of Dr. Ing. h.c. F. Porsche AG, their associated

companies or the Series partners/sponsors on cars, helmets, race suits and other Driver equipment, on team vehicles or on team clothing or any other kind of advertising for these companies, products or services is strictly prohibited.

Also prohibited are advertisements for Driver coaching and/or development programmes (other than the Porsche Junior or Rookie Programmes) and any non-Porsche one-make race series.

- (c) The use of advertisements for companies in the tobacco and sex industry, or political or religious advertising, or private betting and gambling operators on cars, helmets, race suits and other Driver equipment, on team vehicles or on team clothing or any kind of advertising for these companies, products or services or anything that may be deemed by Dr. Ing. h.c. F. Porsche AG to bring the company and/or the Series into disrepute is strictly prohibited.
- (d) The advertising guidelines of the FIA and DMSB as well as general or legally regulated advertising bans must be observed.
- (e) A team partner/sponsor must not support more than two teams with two cars in each case and therefore must not be included in the stickers of more than 4 cars.
- (f) The Competitor is obliged to notify the Series Organiser of all potential team partners/sponsors and obtain written (text form sufficient) approval from the Series Organiser for their use. The Series Organiser is entitled to prohibit Competitors from displaying or promoting in any manner the details of any unapproved partners/sponsors.
- (g) Team partners/sponsors must be registered with the Series Organiser no later than 7 calendar days before the start of the relevant competition (Article 2.1.7. a of the FIA International Sporting Code refers).
- (h) If team partners/sponsors are not registered with the Series Organiser 7 calendar days before the start of a competition (ISC Art 2.1.7 refers), the Series Organiser may refuse the use of any associated advertising material and may also refer the matter to the Stewards of the relevant competition for consideration of the imposition of penalties.
- (i) The Competitor and team partners/sponsors shall grant to the Series Organiser and the Series partners/sponsors all materials depicting the championship and/or rights to use sporting success for advertising purposes, without paying separate fees for this purpose.
- (j) Contravention of any of the advertising regulations may result in a fine of at least EUR 1,000 and/or refusal to participate in any competition or disqualification from the competition, in each case at the discretion of the Stewards.

1.10 Safety equipment

The cars must possess all safety equipment in compliance with Article 277 of Appendix J to the FIA International Sporting Code (Group EII-SH).

The on-board fire extinguisher system must be switched into position "Armed" and the red LED illuminated from the moment a car leaves its team area to travel to the pre-start area for each session and must not be switched off until the car is returned to the team area or Parc Fermé after the session.

Note:

For events held in all of the countries listed in the Series calendar (Article 7.1 of Part 1 Sporting Regulations), the Series Organiser is responsible for observing and implementing (or agreeing any deviation from) any additional safety regulations of the respective ASN.

1.11 Fuel type and single fuel

The following single fuel must be used:

The only permitted fuel is unleaded fuel in compliance with Article 252.9 of Appendix J to the FIA International Sporting Code which must comply with DIN EN 228 and must be from the supplier specified by the Series Organiser at an event of the Series. A new supplier can be designated for each event (fuel pumps, tanker, or similar). Only the specified fuel is permitted to be used for the duration of the applicable event(s).

1.11.1 Fuel controls

The Technical Scrutineers shall be entitled to take fuel from a participant's car at any time during the event. The Competitor must ensure that at any time from the commencement of pre-start for any session or race until the car is released from Parc Fermé at the end of the respective session or race (subject to removal of fuel for the weighing procedure), a minimum of 2.0 kg of fuel can be taken from the corresponding removal point (defuelling coupling of the fuel cut-off valve) in the luggage compartment. These samples must be identical to the reference fuel taken from the fuel supplier designated above.

The defuelling process will be done on the measuring platform of the Technical Scrutineering area. If necessary, the Technical Scrutineers may specify a different location. During the defuelling the vehicle must be stood on the platform (or the ground if a different location has been specified) on all four tyres and must not be moved. The required quantity of fuel must be able to be taken, from the removal point defined above, within a maximum period of 10 minutes after the start of defuelling.

1.11.2 Refuelling, refuelling installations and control

The addition of any additives or any chemical changes to the fuel are prohibited.

Fuelling and refuelling of the cars during free practice, qualifying and the race is forbidden.

Throughout the event the temperature profile of the outdoor air temperature will be recorded by the Technical Scrutineers with the use of a special temperature recorder defined by the Series Organiser. The minimum value of the last 24 hours will be posted on the digital notice board before the first session of each day. At no time is the temperature of the fuel in the car permitted to be less than the lowest outdoor air temperature as posted on the Digital Notice Board.

Any operations involving the handling of fuel require the proper grounding to earth of the car and all equipment involved; in addition, there must be two 9kg ABC Dry Powder or alternatively two 5kg CO2 fire extinguishers present in the area of the fuel operations. Fuel may only be added into or removed from the fuel cell of the car using a closed-circuit fuelling system manufactured by a specialist company (the Series Organiser reserves the right to inspect any system being used and approve or disapprove its use). The exact specification of the closed-circuit fuelling system may be chosen by the Competitor according to their needs (size, pump speed, etc.) however no safety aspect of the system is permitted to be changed.

The fuel will only be supplied in drums and may only be added and removed from the drums with the same closed-circuit fuelling system specified using a suction pipe.

Should there be any circumstances where a Competitor is unable to use the closed-circuit fuelling system, then with the permission of the Technical Scrutineers, any fuel operations must be performed outside the Team tent in a fenced and gated area of at least 5m in each direction of the car. All personnel working in this area must wear full fireproof clothing (including shoes, gloves, goggles, balaclavas, etc.). The car and all equipment must be grounded to earth properly and at least two 9kg ABC Dry Powder or alternatively two 5kg CO2 fire extinguishers with stand-by personnel (not involved in any fuel operations) must be present in this area. Under no circumstances must members of the public, Competitors, team guests or unauthorised personnel be permitted in this area at any time during the fuelling operation; it is the responsibility of the Competitor to ensure that such persons are excluded from the area.

Any work requiring the fuel cell to be opened may only be performed after all fuel has been completely removed from inside the fuel cell and with appropriate protection and fire extinguishers being present at the respective work area.

Smoking and hot works are prohibited when any operation involving fuel or the fuel cell is in progress.

1.12 Technical definitions

In addition to the definitions in the "General Regulations, Definitions and Clarifications regarding the Technical Regulations" (DMSB Manual, blue part) the definitions set out in Article 251 of Appendix J to the FIA International Sporting Code shall apply.

2 Specific Technical Regulations

2.1 General information

General car description

Porsche 911 GT3 Cup (992), MY 2021, 2022, 2023, 2024

Concept: Single-seated, near-standard car based on the Porsche 911 GT3.

For further general descriptions, the Competitor (entrant) shall refer to the respective paragraph of these technical regulations.

Important Information

Certain special parts used in the Porsche 911 GT3 Cup cannot be obtained via the Porsche dealer organisation but instead can only be obtained from the Motorsport Parts Sales Department at Dr. Ing. h.c. F. Porsche AG.

Dr. Ing. h.c. F. Porsche AG Abteilung Sportteileverkauf/EMV4
 Markgröninger Straße 45
 71701 Schwieberdingen Germany
 Tel.: +49 711 911- 89956
 Fax: +49 711 911- 82808
 E-Mail: raceparts@porsche.de

The cars must comply with the requirements of these Technical Regulations. Technical inspection and acceptance of the cars is undertaken by the Technical Scrutineers.

2.2 Engine

2.2.1 General description

- Water-cooled six-cylinder boxer engine
- Displacement 3,996 cm³; stroke 81.5 mm; bore 102 mm Max.rpm: 8,750 rpm
- Single throttle butterfly system
- Intake manifold with two resonance flaps
- Dry-sump lubrication with oil-water heat exchanger
- Race exhaust system with DMSB certified catalytic converter
- Engine control unit Bosch MS 6.6
- Single-mass flywheel
- Required fuel quality: minimum 98 octane, unleaded, to E20

The engines are sealed at the official premises of Dr. Ing. h.c. F. Porsche AG or its nominated representatives, prior to delivery. A car with an unsealed engine or with a damaged seal is not permitted to participate in the Series under any circumstances.

Any work on the engine that requires the seal to be opened is only permitted to be undertaken

at the official premises of Dr. Ing. h.c. F. Porsche AG or its nominated representatives. Before the engines are delivered and refitted, a new seal shall be affixed at the official premises of Dr. Ing. h.c. F. Porsche AG or its nominated representatives

Engines can be called in and inspected at any time by the Scrutineers or on the instructions of the Stewards.

2.2.2 Engine electronic control units

Throughout the entire event, only the engine electronic control units sealed by the Series Organiser are permitted to be used.

The engine electronic control unit including the complete wiring harness must be used without modifications. The Series Organiser or the Technical Scrutineers reserve(s) the right to check or exchange the engine electronic control unit or record the engine characteristic data at any time during the event. The Series Organiser reserves the right to reprogram the engine electronic control units and to seal the plug-in connectors for reading the engine electronic control units at any time during an event. It is thus ensured that the status of the program and data is identical for all participating cars.

It is the Competitors responsibility to ensure that the engine electronic control unit is programmed and only used with the software MS66_PAG992_GT3_0202_992GT3CUP_klg_SC018 during each event.

The Series Organiser must be informed in writing (text form sufficient) **before each event** of the VIN and ECU number if an electronic control unit which is to be used at that event has the capability of traction control.. The traction control capability must be disabled at all times throughout the event.

2.2.3 Exhaust system

Contrary to the general car description (see Article 2.1), the exhaust system, starting from the manifold, for the Porsche Mobil 1 Supercup will be modified completely with the parts listed in the valid Spare Parts Catalogue for the respective car and model year to the version "exhaust system without silencer" (general linguistic usage as "Supercup exhaust system").

2.2.4 Engine oil quick refill

The use of the optional "oil quick filling kit" as shown in the Spare Parts Catalogue is permitted, provided the mounting is fully compliant with the official Dr. Ing. h.c. F. Porsche AG mounting instructions.

The hole in the engine lid required to fit the quick oil fill must be fully covered by Polyurethane clear tape (such as Heli tape or similar).

The use of the engine oil quick fill in the pit lane during any Porsche Mobil 1 Supercup event is prohibited.

2.2.5 Engine Coolant

The only permitted engine coolant is a mixture of 2 litres of corrosion inhibitor (available in the Porsche Motorsport parts catalogue) and 22 litres of distilled water. The use of anti-freeze is prohibited.

2.3 Power transmission (gearbox/differential lock)

2.3.1 General description

Gear ratios

Ring & pinion gear	15/23 $i = 1.533$
Final drive	16/39 $i = 2.438$
1st gear	13/41 $i = 3.154$
2nd gear	17/40 $i = 2.353$
3rd gear	20/37 $i = 1.850$
4th gear	24/36 $i = 1.500$
5th gear	24/30 $i = 1.250$
6th gear	28/30 $i = 1.071$

- Six-speed sequential dog-type gearbox Sealed (for warranty purposes only)
- Internal pressure-oil lubrication with active oil cooling via oil-water heat exchanger
- Mechanical limited slip differential
- Three-plate sintered metal race clutch
- Paddle shift with electronic shift barrel actuator

2.3.2 Ramp breakover angle

The ramp breakover angle of the differential lock is 52° (traction) and 35° (overrun). The ramp angles are determined from the axis of rotation (Attachment 4). The number of friction plates and the assembly order shall correspond to the specification in the Technical Manual and must not be changed. The fitted friction plates must comply in terms of part number, allocation and specification (see Spare Parts Catalogue).

2.3.3 Transmission emergency function

If the transmission emergency function has been switched on, the car must immediately return to the pit lane. The car is not permitted to leave the pit lane again until this function has been deactivated.

2.4 Lubrication system

Lubricants

No less than the minimum quantity of lubricants in the engine and gearbox as specified in the Technical Manual must be used at all times during any event.

The addition of any additives or any chemical changes to the lubricants are prohibited.

Engine

Mobil 1 C40 GT 0W-40 or Mobil 1 ESP X3 0W-40 engine oil is compulsory.

Transmission

Mobilube 1 SHC 75W-90 transmission oil is compulsory.

2.5 Brakes

It is not permitted to modify the car to endurance brake calipers, even if they might be listed in the Spare Parts Catalogue.

2.5.1 General description

- Two independent brake circuits incorporating front and rear axle brake pressure sensors
- Driver adjustable brake force distribution via brake balance system
- Racing brake pads
- Optimized brake ducts
- Ergonomic brake pedal positioning
- Derivative sensors & harness for retrofitting an ABS system

Only standard master brake cylinders are permitted for the 2 brake circuits on the

- Front axle (diameter: 19.1 mm) and
- Rear axle (diameter: 17.8 mm). Cars delivered with brake master cylinders of 15.9 mm diameter need a replacement of the brake master cylinders with 17.8mm diameter from the 2024 Spare Parts Catalogue.

Front axle:

- Aluminium 6-piston fixed calipers, one piece
- Internally vented steel brake discs, diameter = 380 mm, 32 mm thick mounted on aluminium disc bells

Rear axle:

- Aluminium 4-piston fixed calipers, one piece
- Internally vented steel brake discs, diameter = 380 mm, 32 mm thick mounted on aluminium disc bells

The use of any system working like an ABS system is strictly prohibited. For easier handling and more versatile use of the cars besides the Porsche Mobil 1 Supercup, it is permitted to have the following parts of the ABS system offered by Dr. Ing. h.c. F. Porsche AG still in the car during any events of the Porsche Mobil 1 Supercup, provided that all components are fitted in compliance with the official Dr. Ing. h.c. F. Porsche AG mounting instructions:

- ABS ADAPTER HARNESS
- G sensor ABS and TC

2.6 Wheel suspension

- Forged control arms & top mounts: Stiffness optimized
- Heavy-duty spherical bearings with dust protection
- Wheel hubs with centre-lock wheel nut
- Shock absorbers with motorsport specific valve characteristic, non-adjustable
- Double-blade-type adjustable anti-roll bars
- Tyre pressure monitoring system

2.6.1 General description front axle

- Double wishbone front suspension, adjustable ride-height, camber and toe
- Electric power steering with manual function to ease car manoeuvring

2.6.2 General description rear axle

- Multi-link rear suspension, adjustable ride-height, camber and toe
- Motorsport driveshafts optimized for reliability and durability

2.6.3 Permitted adjustments

The suspension is permitted to be modified within the scope of the specified setting range. All genuine parts must be retained. The maximum permissible combined thickness of the camber spacer washers is dependent on the track for each event and is given in the table below:

Front axle 20.0mm	Front axle 19.0mm	Front axle 18.0mm
Rear axle 15.0mm	Rear axle 13.0mm	Rear axle 11.5mm
Monaco Imola Budapest	Spielberg Zandvoort Silverstone Spa-Francorchamps	Monza

The non-removable spacer (part number 9F1.505.184) of the rear lower control arm will be included when determining the combined thickness of the camber spacer washers.

A change to the maximum permissible combined thickness of the spacer washers in the front and rear axle control arms and/or camber values can be announced by Stewards' Bulletin at any time before or during any event.

It is permitted to fix the camber shims in position with aluminium tape.

All bearing points of the front and rear control arms must be left in the position in which they are delivered. The adjustment of the excentre screw at the front upper control arm mounting bracket, within its specified setting range, is permitted.

2.6.4 Anti-roll bars

The anti-roll bars are only permitted to be unhooked provided that one coupling rod of the respective rollbar is completely removed. Only the respective setting options given in the Technical Manual are permitted to be used.

The axial clearance of the anti-roll bars on the front and rear axles must be below 1.0mm. Designated shims shown in the Spare Parts Catalogue are permitted to be used to compensate for the axial clearance.

2.6.5 Shock absorbers/springs

Only the factory-installed type shock absorbers and springs in their original condition are permitted to be used. The original delivery condition of the bump stops must not be modified in any way.

2.7 Wheels (flange + rim) and tyres

2.7.1 General description

Single-piece light-alloy rims according to Porsche specification and design with centre lock.

- Front axle 12J x 18 ET 23.5 mm
- Rear axle 13J x 18 ET 44.5 mm

2.7.2 Wheels

The use of any other wheels than the originally specified wheels is prohibited. All wheels must be fitted with original type of tyre pressure and temperature sensors. Only the use of valve caps mentioned in the respective Spare Parts Catalogue or valve caps supplied by the official tyre supplier are permitted and they must be fitted for all sessions at all events.

The rims are permitted to be painted. It is prohibited to paint or treat any functional surfaces (rim bed, contact area of wheel nut, mounting surface of the wheel). Wheel rims are not permitted to be repaired. The friction strips on the inside of the rim must stay functional and must not be treated in any way.

2.7.3 Tyres

Only the version of Michelin tyres approved for the Series with the following specification and supplied by the official supplier specified by the Series Organiser is permitted to be used for the duration of the events and the official test.

Slick tyres

- Front: 30/65 R 18 Porsche Cup N3
- Rear: 31/71 R 18 Porsche Cup N3R

Rain tyres

- Front: 30/65 R 18 P2L
- Rear: 31/71 R 18 P2L

For the first event following any change in tyre specification, permanent starters and returning Guest Drivers will be allowed to mark a maximum 1 set of the new specification tyres (including any part of the complete set for which the specification has not changed) for the free practice session and a maximum 2 sets for the qualifying session/race. For the free practice session only, at that event, it will also be permitted to use marked tyres of the old specification which were allocated to that competition number in a previous competition of the Series.

Dr. Ing. h.c. F. Porsche AG suggests that all Competitors follow the recommendations and instructions of Michelin regarding tyre pressures and set-up. Only atmospheric air is permitted to be used to inflate the tyres. It is not permissible to rotate the tyres on the rims. It is permitted to refit tyres, but the refitting must be performed by the official tyre supplier.

Should the tyre manufacturer prescribe a rotational direction for its tyres, then any departure from the manufacturer's prescription is prohibited.

2.7.4 Ordering of tyres

The tyres for the relevant event must be ordered from the official tyre supplier at least ten working days before the start of the competition (Article 2.1.7.a of the FIA International Sporting Code refers) using the official order form.

2.7.5 Tyre marking

Throughout these regulations any reference to the marking of tyres includes the procedure of electronically scanning and recording the individual bar codes of tyres.

At each event, and for the duration of each event, a maximum number of sets of new tyres for each car can be marked by the Technical Scrutineers as per the table in Attachment 8 (a set of tyres is defined as two front and two rear tyres).

Tyres are allocated to a competition number and not to a Driver. If a new Driver enters under a previously used competition number then the tyre rules for "subsequent events" as shown in Attachment 8 will apply. This is equally relevant for both Non-Permanent Drivers and Guest Drivers.

The point of time for tyre marking and release is published in the Official Event Schedule (e.g. tyre marking, slick tyres, tyre marking rain tyres, tyre pick-up).

Rain tyres that were marked in a previous event of the current Series may be presented again for marking. The Technical Scrutineer must be satisfied with the condition of any tyre re-presented for marking. Rain tyres must be prepared and ready at the start of the rain tyre marking session (see the respective Official Event Schedule) outside the respective team awnings. Furthermore, the competition numbers must be displayed clearly on each tyre.

2.7.6 Tyre logs

All barcodes of the marked tyres will be recorded in lists (the tyre logs), which will be transmitted to the Competitors. The Competitors must compare the barcodes of the tyres with those of the tyre logs.

Any discrepancy between the listed barcodes and the barcodes of the tyres must be communicated by the Competitor to the Technical Scrutineers in writing (text form sufficient) no later than one hour before the beginning of pre-start for the session in which the respective tyres may be used for the first time.

If there is no such communication, this will be deemed as implicit acceptance of the received tyre logs.

With the exception of rain tyres during free practice, no tyre is permitted to be used that is not listed on a tyre log for the relevant car.

2.7.7 Free practice

For the free practice session, only tyres as shown in Attachment 8 must be used.

2.7.8 Qualifying and race

Only the tyres marked for the relevant event are permitted to be used for the respective qualifying and race, as shown in Attachment 8. Only correspondingly marked tyres are permitted to be taken into the pit lane for qualifying and the race of the respective event.

For the avoidance of doubt, slick tyres marked for free practice (where this is provided for) or used in free practice may not be brought into the pit lane for, or used during, qualifying or the race.

2.7.9 Tyre damage

If a marked tyre is damaged during qualifying or in a race, should the Competitor wish to change the tyre then he must notify the Technical Scrutineers up to a maximum of two hours after the end of the Parc Fermé.

Damaged tyres can only be exchanged with the approval of the Technical Scrutineers and in agreement with Michelin. The Technical Scrutineers have the authority to declare damaged tyres as unsafe and insist that they are replaced. In this case, marking of the tyres by the Technical Scrutineers is necessary.

It is not permitted to replace more than one marked tyre throughout a complete event without penalty. If more than one marked tyre needs to be replaced throughout the duration of an event, the relevant car will start the next race from the last position on the starting grid.

Where a marked tyre is replaced after a race, this will be deemed to have taken place during that event and any consequent penalty will be applied to the relevant starting number at the next race in which it takes part.

The Stewards will make the final decision regarding the imposition of the penalty. The cars that qualified behind the respective penalised Driver will move up the grid by one position. If several cars are subject to the above rule, the corresponding cars/Drivers will be lined up at the back of the starting grid in the order of their qualifying results. This applies for slick as well as rain tyres.

2.7.10 Treatment

Any chemical, mechanical or thermal treatment of the tyres is prohibited. Cleaning of the rims is permitted. The mechanical removal of rubber abrasion and stones is permitted. The usage of heat guns or any similar devices of any kind to help the removal of rubber abrasion and stones (“tyre scraping”) is prohibited. The use of heated covers, materials or other means of changing or preserving the temperature of the tyres is prohibited for the entire duration of an event. From the time of the pre-start until the end of any session, approved tyres are not permitted to be covered. This applies for slick as well as rain tyres.

2.8 Bodywork and dimensions

2.8.1 General description

- Lightweight body featuring intelligent aluminium-steel composite design
- Integrated (welded) roll-cage in accordance with FIA regulations (permitted for co-Driver usage on circuit events)
- Front cover with integrated quick-release fasteners; cooler exit-air duct and central air intake for cockpit ventilation
- Removable rescue hatch in accordance with the latest FIA safety regulations
- Mounting points for lifting device
- Fenders with extensions
- Widened front bumper with spoiler lip
- Rear bodywork with integrated rain light in accordance with FIA regulations

Lightweight exterior:

- Carbon-fibre reinforced plastic doors with quick release push button
- Carbon-fibre reinforced plastic rear lid with integrated quick-release fasteners; removable
- Carbon-fibre reinforced plastic adjustable rear wing with ‘swan neck’ mounting (11 positions)
- Polycarbonate windows with hard coating
- Rear underbody panelling with NACA ducts for brake, driveshaft and shift barrel actuator cooling

Modified 911 cockpit:

- Carbon-fibre reinforced plastic interior trim panels
- Ergonomic digital touch panel with multi-colour backlight aligned towards Driver
- Multifunctional carbon-fibre reinforced plastic motorsport steering wheel with quick release coupling, shift paddles and illuminated push buttons
- Adjustable steering column with steering angle sensor
- Safety nets (centre and Driver’s side) in accordance with latest FIA safety regulations
- Optimized cockpit ventilation featuring airflow directed at Driver

- Racing bucket seat in accordance with FIA Standard 8862/2009
 - Infinite longitudinal adjustment, two positions for height and inclination adjustment
 - Padding system in three sizes to adapt seat to individual Drivers
 - Preparation for seat ventilation
 - Six-point racing safety harness
- FT3 safety fuel cell (approx. 110 litres) and dry break couplings for fuelling and draining using a fully enclosed system
- 'Fuel-Cut-Off' safety valve in accordance with FIA regulations
- Integrated air-jack system (three jacks) with valve mounting points on either side of the car
- Colours:
 - Body painted with water-based paint
 - Exterior: GT-silver-metallic (M7Z)
 - Interior: GT-silver-metallic (M7Z), without clear lacquer finish
 - Rims: Platinum semi-matt (OB5) Rear wing in naked carbon

2.8.2 Overall car dimensions and overhangs

The total length of the car is 4,585 mm (180.51 inch) +/- 15mm.

The track width of the front axle measured at the centre of wheel hub plugs is 1885 mm (74.21 inch) +/- 10mm.

The track width of the rear axle measured at the centre of wheel hub plugs is 1855 mm (73.03 inch) +/- 10mm.

The front overhang is 1,036.0 mm (40.79 inch) +/- 15.0 mm, measured from the middle of the wheel of the front axle to the leading edge of the car (first point in the direction of the longitudinal axis, including front lip).

The rear overhang is 1,081.0 mm (42.56 inch) +/- 15.0 mm, measured from the middle of the wheel of the rear axle to the rear edge of the car (last point in the direction of the longitudinal axis, including the exhaust, rear wing excluded).

The wheelbase of the car is 2,468.0 mm (97.16 inch) +/- 15.0 mm, measured at the centres of the wheel hubs.

2.8.3 External bodywork (including windows)

The delivery status of the bodywork must be preserved.

2.8.4 Windscreen

As a replacement to the original part, a heated windscreen as shown in the Spare Parts Catalogue is permitted. The heated windscreen is permitted to be connected to the electrical system of the car and the heating function is permitted to be used.

To protect the windscreen and as a safety measure, 'tear-off' screens are permitted to be attached to the windscreen. Fitting will be checked during technical scrutineering and must be removed where applicable on request of the Technical Scrutineers.

2.8.5 Side and rear windows

Any covering of the side and rear windows by any form of tape or film (other than in compliance with the Sticker Regulations) is not permitted.

2.8.6 Cockpit

Seat

The adaption of the seat by the addition of original Sabelt seat padding shown in green and blue in Attachment 6 is permitted.

Each padding shape may only be used in the specific and correct location and direction as shown in Attachment 6.

Additional padding at the head rest can only be added in accordance with the following conditions and subject to the Technical Scrutineers' approval:

- The foam used for the padding must be the same material as the one used on the head rest by the seat manufacturer.
- The padding must be properly fixed to the seat.

Any addition or removal of material below the surface shown in black is forbidden.

A foamed seat insert, according to Article 253-16 of Appendix J to the FIA International Sporting Code, may be used as long as the insert is made of fireproof material, coloured in black. The use or change is subject to approval by the Technical Scrutineers.

The original seat mounting (seat rails and bracket) must be retained and must not be modified.

The provisions of Article 253 - 16 of Appendix J to the FIA International Sporting Code must be complied with at all times.

The weight of the foamed seat insert will be included in the weight of the car, not in the Driver's weight.

Ventilation in the passenger compartment

Only the factory-fitted ventilation pipe (NACA-intake on the front opening hood) is permissible for cockpit ventilation. The ventilation of the windscreen must not be affected. For additional ventilation of the passenger compartment only the existing original ventilation openings in the rear back windows are permissible.

Safety nets

Every car must be equipped with safety nets mounted in compliance with the official Dr. Ing. h.c. F. Porsche AG mounting instructions.

2.8.7 Additional roof hatch accessories

The car has a roof hatch (to facilitate Driver extrication) which is connected to the roof via 7 liveness and which must be accessible at all times (no foiling or painting of live locks is permitted).

2.8.8 Ground clearance of car

The minimum ground clearance of the ready-to-drive car (with the Driver in the car and tyres in compliance with Article 2.7, at 2.0 bar \pm 0.1 bar air pressure) must not be less than the specified dimension, as measured at the specified measuring points, at any time during the event.

For the entire duration of the event the ground clearance of the front axle is to be a minimum of 72.0 mm and the clearance at the rear axle a minimum of 106.0 mm. The measuring points (see Attachment 5) at the front axle are the mounting bolts of the cross member/bodywork in relation to the reference surface and the machined rear surface in the direction of travel on the side section of the rear axle in relation to the reference surface. The ground clearance is permitted to be changed within the existing adjustment range.

The minimum ground clearance for the front axle, as specified above, must be achieved with the reinforcement sleeves 9F1.407.371 fitted on the subframe, as well as undamaged and unmodified mounting bolts (part number WHT.008.757). The height of an undamaged and unmodified mounting bolt head will be defined as 11.8mm. If the height of the mounting bolt heads fitted to the car during the ground clearance measurement measures less than 11.8mm, the difference will be taken into account.

2.8.9 Measuring location and method

The measurement of the minimum ground clearance is conducted on the measuring plate in the technical scrutineering area. The measuring plate is available to the participating teams to check the minimum ground clearance at all times in consultation with the Technical Scrutineers.

The minimum ground clearance is checked using an appropriate height gauge for the axle to be measured in each case. The measurement is checked with the ready-to-drive car including the Driver on board, standing on the measuring plate. If the measuring gauges can be correctly accessed under the measuring points described above, the requirement to comply with the minimum ride height is satisfied. If the Driver is not available at this point, a substitute person of the same or higher weight as the Driver in this session must take the Drivers place. Any measuring tolerances will be taken into account by the Technical Scrutineers.

The Technical Scrutineers may at any time at their absolute discretion check the ground clearance measurement with any set of tyres allocated to the respective competition number and used during the session that the check is performed during or after. The Technical Scrutineers may also use instruments such as calipers or depth gauges to determine the car's ground clearance.

2.8.10 Failure to reach minimum ground clearance

Failure to reach the minimum ground clearance during the qualifying session may be penalised with the deletion of the times achieved by the Driver concerned. The Driver may be permitted, however, to

take up the race from the last place on the starting grid, subject to the Stewards being satisfied with regard to the 107% qualification requirement. Failure to reach the minimum ground clearance in the race may result in disqualification from the points classification for the race.

2.9 Aerodynamic devices

The original position of the wing section is permitted to be changed within the specified scope for adjustment provided by the Technical Manual.

It is permitted to tape over the full area of the headlight lenses with transparent Polyurethane tape (such as Heli tape or similar).

Taping over of any slots in the bodywork, wings or other permanent parts, joints and openings is not permitted, with the sole exception of taping over the slots between the fuel filler door and the surrounding front fender.

The use of the front air scoop (part numbers 9F1.407.811 and 9F1.407.812) is mandatory for each event.

Any alteration or amendment outside the above set parameters will render the car non-compliant with the Technical Regulations and may be subject to penalties from the Stewards.

2.10 Electrical equipment

General description

- 10.3" Porsche colour display Porsche logger
- Porsche power box
- Fire extinguisher system (extinguishing agent: NOVEC gas)
- Lightweight 12 V, 60 Ah battery (LiFePO4) leak-proof, installed in co-Driver's footwell
- Digital touch panel with multi-colour backlight
- 175 A alternator
- Single-arm windscreen wiper with direct drive (intermittent and continuous operation)
- Three additional centre console switches for additional power consumers
- Data connection (data logger, video system)

LED Lighting system

- Main headlights
- Daytime running lights
- Taillights
- Rainlight in compliance with FIA homologation regulation

The usage of the following electrical equipment from the Dr. Ing. h.c. F. Porsche AG- and Manthey Spare Parts Catalogues is mandatory:

- AS SENSOR GPS

Optionally, the usage of the following electrical equipment from the Dr. Ing. h.c. F. Porsche AG- and Manthey Spare Parts Catalogues is permitted:

- Z HARNESS USB
- RLU RUGGED USB MEMORY
- MTH000116A – AS Charging cable (installation according to latest mounting instructions)
- MT001179A - AS USB Memory holder

It is not permitted at any time for any Competitor, with any equipment, to read any sensors which are not allocated to the Competitor's own team. Any Competitor breaching this regulation may be disqualified from the relevant session, race, or competition.

2.10.1 Data transfer

The use of radio-based information transmission in the car (e. g. telemetry) is forbidden, the only exception is the usage of the built-in tyre pressure monitoring system, which uses radio transmission for its functionality.

2.10.2 Radio system

Only the radio system made available by the Series Organiser is approved for use. The Driver must be connected to the radio system during every session and must be able to receive instructions from the Race Director or the Series Organiser from the point of leaving the pre-start area until the car is parked in the team awning or in Parc Fermé.

Should the radio system not be operational by the start of a session (free practice, qualifying or race), the Race Director may prohibit the car concerned from participating in the session until the radio is operational.

Malfunctions or damage to the system must be reported immediately to the Technical Scrutineers. The choice of hardware for radio reception from the "Earplug" port to the Driver is optional but must be checked and approved by the Technical Scrutineers. Further modifications to the radio system are not permitted. Extra equipment is only permitted to be coupled with the radio system by the Series Organiser.

When mounting fixed speakers in the Driver's helmet, the FIA helmet regulations must be strictly observed.

In the case of any ambiguity, the Driver/ Competitor must produce proof that the components used are suitable for use in the car (fire prevention, etc.).

On written (text form sufficient) request by the Competitor, the Series Organiser can also release the communication between team and Driver. The Series Organiser has the right to listen to voice radio communication between the Team and the Driver separately.

The radio system is the property of the Series Organiser and must be returned to the Series Organiser in proper order after the last race of the season.

Correct installation of the radio system must be approved by the Technical Scrutineers.

On written (text form sufficient) request by the Competitor, the Series Organiser may authorise that a separate radio loom can be carried in the car, providing it is completely electrically disconnected from

the car and does not interfere with or alter any function of the car or the official radio system. The installation of a separate radio loom must be approved by the Technical Scrutineers. The Series Organiser may withdraw such authorisation at any time during an event.

2.10.3 Data recording

Use of the factory-fitted data recording system manufactured by COSWORTH is compulsory. The COSWORTH system is assigned to the car's chassis number and must not be exchanged. Only the setups approved by Dr. Ing. h.c. F. Porsche AG are permitted to be used for the duration of the event.

Only the infrared pit wall beacon signal provided by the Series Organiser may be used to create lap times in the recorded data.

All recorded data relating to the competition must be made available to the Technical Scrutineers and/or the Series Organiser including service providers.

Any additional electrical connection to the car's wiring harness is not permitted. Installations set up by the Series Organiser are exceptions to this rule.

Where the Series Organiser requires an additional part or system to be fitted for development purposes, the Competitor is not permitted to access any of the associated data unless specific agreement is given in writing (text form sufficient) by the Series Organiser.

Directly after parking in Parc Fermé, the Driver is permitted to remove the optional RLU RUGGED USB MEMORY from his car. The removal by any other person or removal by the Driver at a later time before the end of Parc Fermé is prohibited.

2.10.4 Timing Transponder

Only the transponder provided by the Series Organiser is permitted to be used throughout the entire competition. The timing transponder must be mounted as shown in Attachment 7.

2.10.5 Cameras

Only in-board or on-board cameras which have been approved by the Series Organiser and/or FOWC for legal sporting matters and TV purposes are permitted to be used. All participants are obliged to fit and use the TV cameras assigned by the Series Organiser and/or FOWC in the respective car at the defined place according to the FOWC standards. Installation shall take place in the Team's working awning by trained personnel of the Series Organiser and/or FOWC staff.

The memory cards can only be removed from the cameras by the personnel nominated by the Series Organiser.

Any breach of this regulation, or any other unauthorised interference with the camera system can result in the Competitor and Driver being disqualified from the competition.

For image rights and copyright, see Article 16 of Part 1: Sporting Regulations.

The camera system provided by the Series Organiser fully remains the property of Series Organiser at all times. Any damage to the camera system will be repaired at the expense of the initiator of the damage / Competitor.

2.11 Miscellaneous

2.11.1 Seals

The following seals are affixed at the works:

Engine

- Valve cover, left (1x) Valve cover, right (1x)
- Oil pump bottom (1x)

Engine control unit

- Connector for control unit wiring harness (2x)

If seals and marks are applied to the car by the Technical Scrutineers or Dr. Ing. h.c. F. Porsche AG, these must not be damaged, changed or reproduced. If one or more damaged or missing seals or markings are discovered, the car may be disqualified from the event.

If any of the seals on the engine control unit are opened to allow welding work to be carried out, the control unit must then be taken to the Technical Scrutineers for an additional inspection and then be resealed, without being requested to do so. The removed seal(s) must be handed over to the Technical Scrutineers.

Seals that have fallen off during the race or are damaged must be notified to the Technical Scrutineers in writing (text form sufficient) no later than one hour after closure of the "Parc Fermé".

2.11.2 Electronic car configuration

Throughout each event, the car must be run with the following configuration settings:

- traction control and ABS variant "Basis" and the logged channel "log_car_variant" with the value "1" visible in the display
- exhaust system setting on standard with "CW_SILENCE" visible in Racecon and the logged channel "B_silence_pt" both with the value "0"

2.11.3 Additional fixation rear brake air duct

It is permitted to secure the two halves of the air duct element (part numbers 9F1.615.457, 9F1.615.458, 9F1.615.447 and 9F1.615.448), using a maximum of 3 cable ties around each element, to prevent their separation

2.11.4 On-board marshalling systems

On written (text form sufficient) request by the Competitor, the Series Organiser may authorise that the antenna, GPS receiver, wiring and display of the marshalling system of any national Porsche One Make Series can be carried in the car, providing it is completely electrically disconnected from the car and does not interfere with or alter any function of the car. The installation of that separate system

must be approved by the Technical Scrutineers. The Series Organiser may withdraw such authorisation at any time during an event.

Part 3: Environmental Regulations

1 Introduction

The Environmental Regulations (ER) apply to all participants engaged in the PMSC. The latest version will be valid and will be posted on the Digital Notice Board (Edubreak), copies also available upon request from the Series Organiser. Implementation is mandatory and must be incorporated in the daily duties and activities of groups and individuals.

With the support of the PMSC Environmental Officer (EO), it is the responsibility of each Team Manager and representative to ensure that each of their team members, employees and contractors are familiar with the requirements of the PMSC ER. This also applies to event-specific information or amendments.

For the purposes of this ER, the 'environment' will be the venues that the PMSC operates within.

The ER will be implemented by everyone involved in the PMSC and will be overseen by the PMSC Environmental Officer, who will be responsible for monitoring and ensuring compliance with its provisions. Competitors must make every effort to minimise the environmental impact of their operations in accordance with the ER and must cooperate fully with the EO in the implementation of the environmental protection measures detailed in these regulations. The EO will inform, educate, and support all those within the venue on environmental matters.

Each PMSC participant will be responsible for the behaviour and actions of all persons associated with their entry. In case of breaches of the regulations, these will be reported to the Stewards by the EO. Payment of any financial penalty will be donated by DMSB to an environmental charity and there will be no right of appeal against such decisions. For particularly serious or persistent breaches, the participant may be disqualified/excluded from an event or suspended from all or part of the Series. In addition, the individual / organisation may be liable for the damages caused by their non-respect of the environmental provisions.

The decision of the Sporting Committee shall be final regarding any interpretation of these Regulations. The Series Organiser reserves the right to amend and extend these Regulations (in consultation with the DMSB).

2 General Environmental Regulations and Guidelines

2.1 Protection of the Ground, Water and Air

The three most common areas of potential pollution are the ground, the air and local water supplies. Therefore, the following actions must be taken:

- (a) The prevention of leaks of fuel, oil, cleaning, degreasing, cooling and brake fluids, or other contaminants into the ground.
- (b) The provision of suitable containers/facilities to recover rubbish, oils, detergents, etc.

- (c) The provision for the treatment of any spillage and the disposal of contaminated material.
- (d) The strict enforcement of procedures to prevent persons from emptying on to the ground waste liquids from vehicles or other facilities located in the paddock. Waste liquids should only be disposed of at the circuit if the venue organiser has provided a proper facility to allow this.
- (e) Upon departure, leaving the paddock in the condition it was initially found and without any evidence of any PMSC activity.

2.1.1 Vehicle Washing

- (a) If designated wash areas are available at the venue, these must be used for all vehicles (trucks, cars, quads, etc.). The precise areas where vehicle washing is permitted will be defined by the PMSC EO for each event and competitors must only use the designated areas.
- (b) Only water, without the addition of soap or detergent, is recommended. If soap or detergent is used, it must be biodegradable and the pH-value of the concentrate must be between 5.0-10.0. Additional specific requirements may apply for each event.

2.1.2 Waste and sewage

Based on the available waste separation of the circuit, all waste must be disposed of properly. Waste must be retained by the participant until the approved facilities provided by the venue organisers can be used.

The waste producer has the initial and overall responsibility to place the waste in the available and correct container or location. Each participant and/or team member is responsible for the waste generated by their team during the event. Competitor teams and associated guests must acquaint themselves with the regulations applicable to each event.

Used tyres must be retained by the teams or manufacturers. The use of disposable tableware should be avoided wherever possible.

Wastewater must be fed to the appropriate wastewater intake; all requirements regarding the separation of oil, grease, and chemicals must be observed, just as the local water management regulations should be observed. Under no circumstances may wastewater be sent directly to local rivers or water courses.

Should the Event Organiser identify any specific policy regarding Waste Management, this information will be communicated to everyone within PMSC and must be complied with.

Competitors should ensure waste in their team awnings is stored away from drains, boreholes, wells, and controlled waters.

Team bins must be in good condition and, when required, covered to prevent dust and litter being blown out. If there is any likelihood of stored waste contaminating the surrounding environs, all necessary steps must be taken to ensure no contamination occurs. This may include the use of containment bunds with rain shelters and the use of sealed containers. Where any hazardous waste is disposed of, those responsible must ensure that any local regulations or requirements (such as control documentation) are complied with.

2.2 Sound Levels

2.2.1 Introduction

There may be concerns regarding sound levels at events beyond the cars themselves, particularly if there are local noise restrictions.

The Series Organiser will request from the Event Organisers any information regarding magnitude of sound from public address systems, crowds and other sources associated with an event. This ER deals specifically with the measures being taken by PMSC.

2.2.2 Specific Sound Levels

Should the Event Organiser identify any national, regional or event specific regulations governing sound levels, this information will be communicated to Competitors, who must ensure these are respected.

2.2.3 Power Generation

The provision of electrical power will, wherever possible, be via a permanent power supply as opposed to the use of generators. It will be the responsibility of the electrical power provider to make this as energy efficient as possible, e.g., a permanent supply rather than a portable generator.

Each participant who needs to use a portable power generator must inform the EO and have it approved before operation. It must conform to the following criteria:

- (a) Located away from personnel to avoid disruption due to noise and vibration.
- (b) Be 'super silenced' so that emitted noise is kept to a minimum level.
- (c) Be sized to the optimum level so that it is neither running to its capacity or being over large and therefore not efficient.
- (d) Be surrounded by screening.
- (e) Only be operated during the required hours and not unnecessarily at any time.

2.3 General Paddock Activities

The methodology in which work activities are undertaken should apply Best Practicable Means (BPM) to minimise any nuisance or negative impact on local, sensitive receptors, such as members of the public and any neighbouring populated areas.

The following measures should be considered when attempting to reduce noise and other nuisance factors:

- (a) Use dust extraction equipment when drilling and cutting.
- (b) Locate equipment away from sensitive receptors.
- (c) Use temporary screens to act as acoustic barriers.
- (d) Isolate equipment when not in use.
- (e) Fit white noise systems on vehicles to reduce noise nuisance when reversing.
- (f) Keep engine compartment covers closed.
- (g) Limit vehicle movements in the paddock.
- (h) Only run vehicle engines when absolutely necessary.

2.4 Travel & Accommodation

Environmental considerations should also extend to travel and accommodation whilst attending a PMSC event.

2.4.1 Travel

Whenever organising travel to/from an event, the following should be taken into consideration:

- (a) Rent vehicles with good fuel economy, particularly hybrid or electric vehicles.
- (b) Plan for multiple occupancy – avoid single person rental.
- (c) If feasible, use minibus type vehicles instead of several cars.

2.4.2 Accommodation

Whenever organising temporary accommodation (hotels, apartments, etc.), the following should be considered:

- (a) The location of the accommodation to avoid long journeys to/from the circuit.
- (b) The environmental rating of the accommodation.
- (c) The environmental policy of the accommodation.

2.5 HGV Tractor Units

Wherever possible, HGV tractor units which run on HVO (Hydrotreated Vegetable Oil) should be used (or fuels available that could immediately replace diesel in existing vehicles that would help to meet these targets). Many trucks that are already on the road can run on HVO, which is a form of renewable diesel that has been produced from renewable and sustainably sourced vegetable fats and oils. Unlike regular biodiesel, hydrogen is used as a catalyst in the creation process instead of methanol. HGV tractor units and any other support vehicles must not be left with engines idling more than is necessary to power systems, fill air tanks or move vehicles.

2.6 Emergency & Incident Preparedness

In order to minimise the risk of a pollution incident, Competitors must ensure all staff members and their contractors understand the environmental risks associated with their work activity and what control measures are in place to eliminate or reduce negative environmental impact. They should recognise any lapse in such measures and, should an environmental incident occur, it must be immediately reported to the PMSC Environmental Officer who will instigate appropriate remedial measures.

2.7 Publicity / Advertising

Competitors are not permitted to:

- (a) Attach posters to trees, bushes, or other forms of plant life.
- (b) Place signage or advertising without having obtained permission from the PMSC Series Organiser.
- (c) Distribute leaflets / pamphlets or other forms of advertising material without the prior permission of PMSC.

2.8 After the event

Competitors must ensure that:

- (a) Any signage, posters or other advertising is removed.
- (b) Any waste is removed and the surroundings cleaned up before departure.
- (c) Any damaged or discarded parts are removed or, where facilities permit, deposited in appropriate waste containers.
- (d) All waste is placed in the relevant and designated waste-containers.

3 Specific Team Environmental Regulations and Guidelines

Prior to the first event at which the team will participate, the Environmental Scrutineering Document provided to participants by the EO must be completed fully and sent electronically to the EO. The deadline for submitting the fully completed EO Scrutineering Document is the official communicated Team Truck Paddock Entry time. If there are any changes to the declarations or if the team wants to communicate a positive sustainable action, the team is responsible for electronically resubmitting the document with the changes to the EO before they are applicable at the venue. The correctness of the declarations in the transmitted document can be checked by the EO at any time.

3.1 Collection of Hazardous Liquids / Environmental Mat

An absorption mat measuring approximately 1.60 x 3.75m must be available for each competing car at all times during each event.

The mat must be liquid-tight, tear-resistant, and highly absorbent. It must be composed of an absorbent upper part and an impermeable lower part and particularly suitable for absorbing oily liquids.

A suitable mat will be issued to the teams at the Season Test or to Guest starters at their first event of the season. In case of loss or damage of the mat, the team must provide a suitable replacement of their own. The mats are reusable, but it is the team's responsibility to assess when a mat can no longer be used according to the defined requirements / manufacturer's instructions and needs to be replaced. Any such replacement must be provided by the team. The replacement of a mat can also be instructed by the Environmental Officer at any time. During a PMSC event, the proper disposal of a contaminated mat must be discussed with the Environmental Officer.

Each team must also have a sufficient number of containers suitable for collecting liquids. The mats are more suitable for collecting oily liquids, while the containers should be used, for example, for coolant.

The Environmental Mat and suitable containers must be readily available for immediate use or already be placed underneath the relevant part:

- (a) Wherever work on cars is undertaken, where liquids may leak.
- (b) In the Parc Fermé and when unloading recovered, damaged vehicles.

- (c) During all sessions in the pit lane. In addition the blue canister for coolant and a suitable funnel must be taken into the pitlane for all sessions in order to be able to transport any leakage safely back to the paddock for proper disposal.
- (d) When any refuelling is undertaken, which is not carried out with a closed-circuit fuelling system.

A suitable absorption mat must also be placed under all fuel-powered generators.

Each Competitor must ensure at all times during events that hazardous liquids are collected by suitable containers or absorbing sheets (as above) and disposed of in the designated area(s). Any hazardous liquid container must be stored in a separate container that holds any spillage or overflow. Competitors should be aware that fluids may still seep through a mat and, even where a suitable mat is used, they must take all necessary steps to ensure that no harm comes to the ground.

3.2 Disposal of Hazardous Liquids

Environmentally harmful liquids such as oil, coolant (with or without antifreeze) and brake fluid must be disposed of in the designated containers. All liquids must be retained by the team until the approved facilities provided by the venue organisers can be used. Each team member has the initial and overall responsibility to place the waste in the available and correct container or location. If no suitable containers are provided, the team must take the liquids for disposal in a leak-proof container. For this purpose, three canisters per Competitor licence will be handed out by the EO at the Season Test or at the first Guest start. These canisters must be brought to each PMSC event and may only be filled with the prescribed liquids:

- 1x 20 litre canister in yellow for brake fluid
- 1x 20 litre canister in red for oil
- 1x 30 litre canister in blue for coolant

It is the responsibility of the teams to ensure that each team member is familiar with and adheres to the colour code.

3.3 Tyre Cleaning

Tyre cleaning by water should only be undertaken if all wastewater is collected and disposed of in the designated area(s).

Only water, without the addition of soap or detergent, is recommended. If soap or detergent is used, it must be biodegradable and the pH-value of the concentrate must be between 5.0-10.0.

Otherwise, the tyre washing machines provided by the Series Organisation must be used.

Additional specific requirements may apply for each event.

3.4 Fuel

- (a) Only fuel specified in the regulations may be carried and used.
- (b) The fuel should be stored strictly in accordance with the supplier's instructions.
- (c) Fuel should be installed into and extracted out of the racing cars using the closed system specified.
- (d) Any fuel spillage must be immediately cleaned up using proprietary cleaning products.
- (e) Any spillage must be immediately reported to the PMSC EO.

3.5 Gravel

It is possible that cars may pick up gravel when driving through gravel traps or after other cars have brought gravel onto the track and then carry this back to the pit lane or the paddock. Any such gravel which is cleaned out of the cars must be collected and returned to the circuit maintenance team. In the pit lane, gravel must be swept up by the relevant team and returned to the paddock. The necessary equipment must be brought by the teams themselves. In the paddock / team awnings, gravel must be swept up and also returned to the circuit maintenance team.

3.6 Engines

The starting and running of engines will be restricted to specified times. The event timetable will define the time periods when engines may be run. No engine is permitted to be run unless it is essential to do so, and then only for the minimum time necessary.

3.7 Storage of Fuel, Oils & Chemicals

Containers should be stored within a Spill Container, Bund, or any other suitable secondary containment system (SCS). All containers should be in a safe place to minimise the risk of damage and locked-off when not in use. For oil tanks, intermediate bulk containers and mobile bowsers the SCS should be able to hold:

- (a) Where one container is being stored - a minimum of 110% of the total volume.
- (b) Where more than one container is being stored - a minimum of 110% of the largest container's storage volume, or at least 25% of their total volume (whichever is greater).
- (c) For drum storage, the interceptor tray should be able to hold at least 25% of the total storage capacity of the drums.

Bunded areas should be made impermeable to water and oil. The base and walls should not be penetrated by any valve, pipe or opening that is used for draining the system.

Part 4: Attachments / drawings

Attachment 1 – Badge Regulations 2024*

In due time prior to the first event, all Competitors entered for the 2024 Series will receive an adequate number of the obligatory badges for their Drivers' racing overalls. All obligatory badges must be sewn onto the Drivers' overalls in accordance with the specifications below.

Any affixing of badges onto overalls must be done in a professional manner and in compliance with ISC Appendix L Chapter III Article 2.

The following positions must be used for the affixing of obligatory badges:

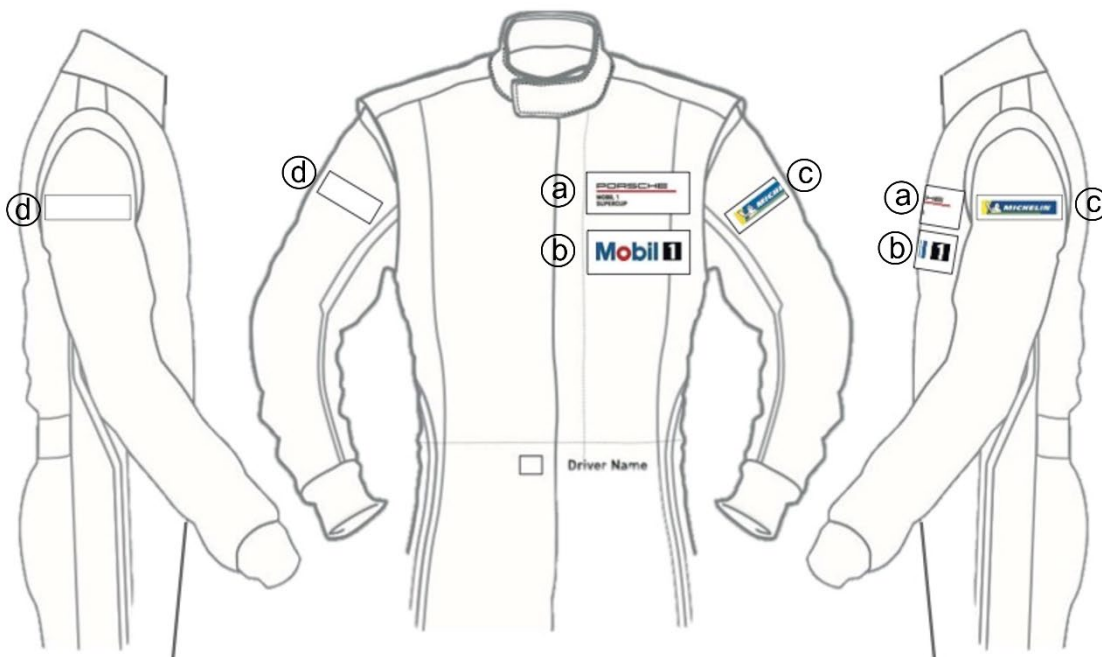

Logo positions (each width 130mm)

- a Porsche Mobil 1 Supercup Logo
- b Mobil 1 Logo
- c Michelin Logo
- d Reserved for Porsche AG

* Subject to amendments.

Attachment 2 – Sticker Regulations 2024 (1/6) *

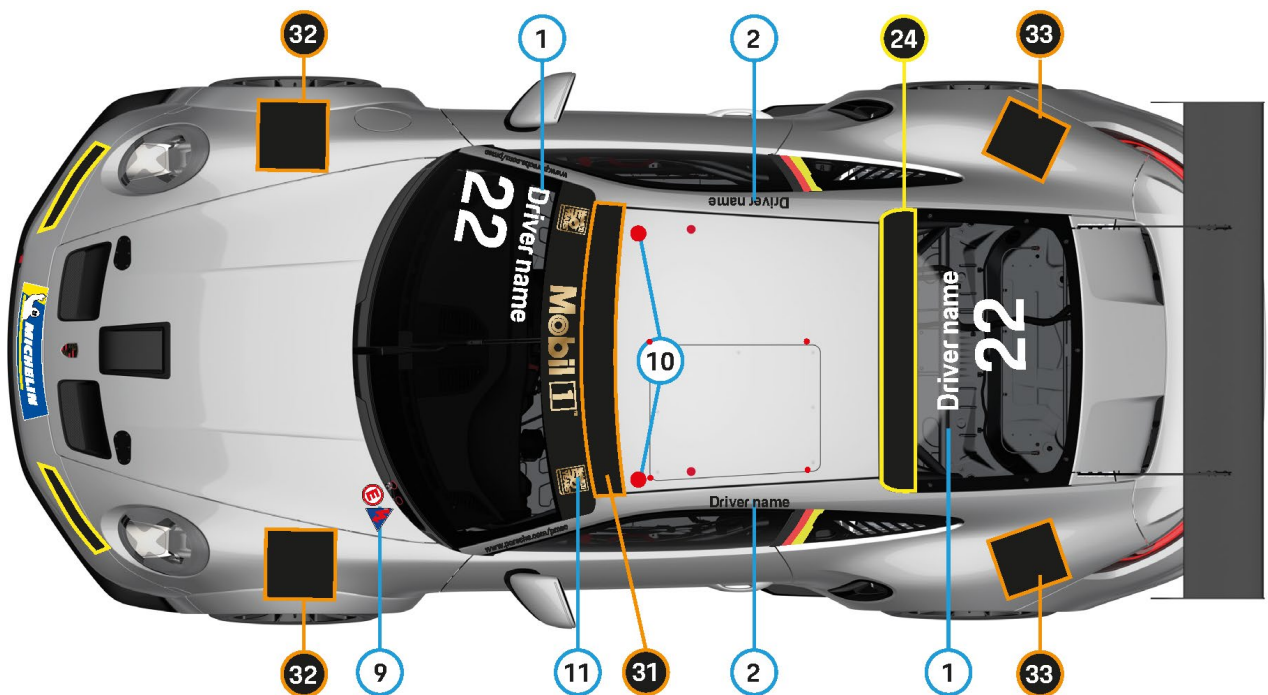
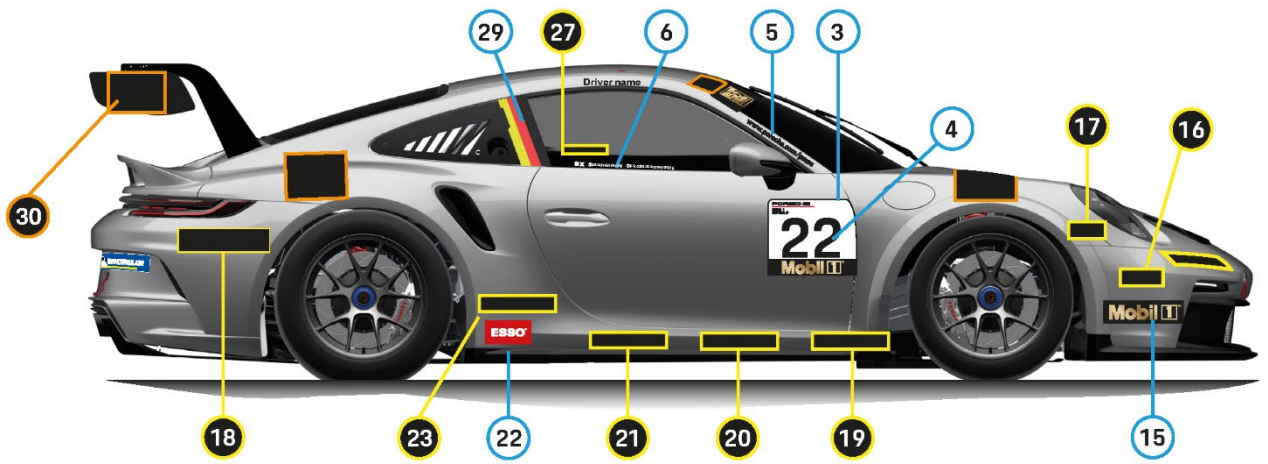
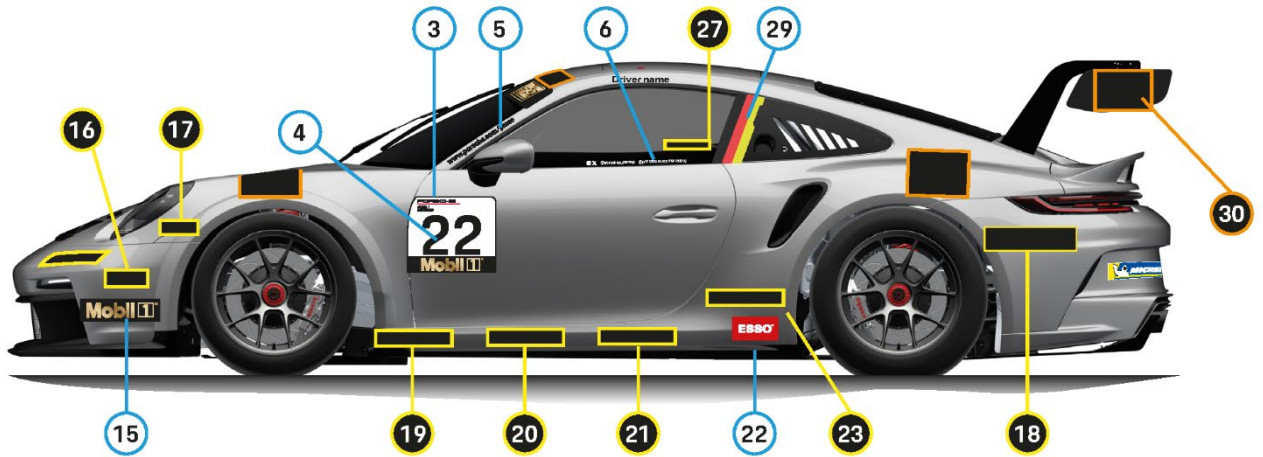

Attachment 2 – Sticker Regulations 2024 (2/6)*

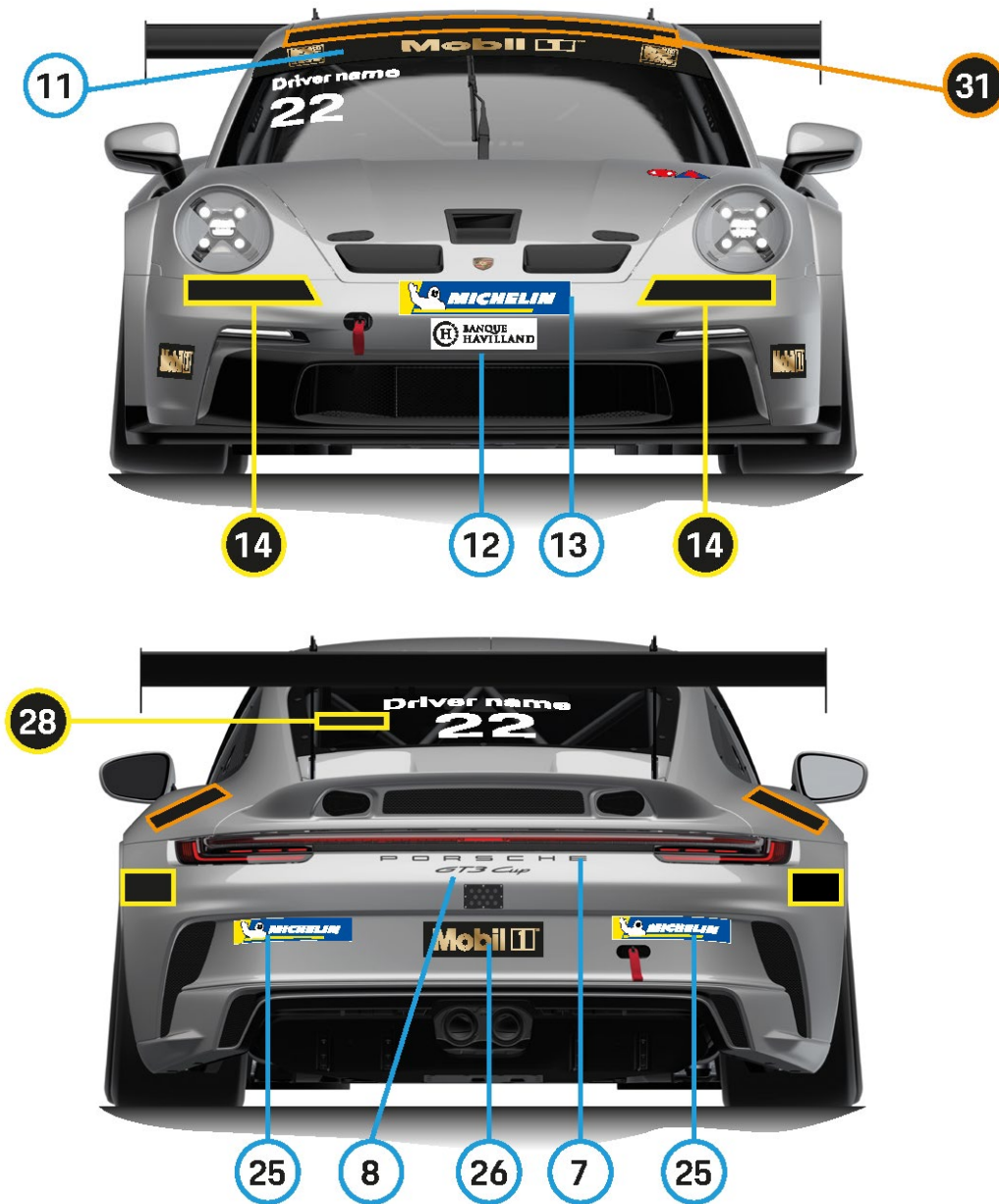

PORSCHE

**MOBIL 1
SUPERCUP**

○ Porsche Mobil 1 Supercup
Manufacturer / Series Specifications, Series Partners

● Reservation Porsche AG

● Reservation PMSC Junior

Attachment 2 – Sticker Regulations 2024 (3/6)*

Number	Quantity	Size (in mm)	Colour	Logo/Symbol	Placement
1	2	100 / 200 height	white	Driver's name (100mm) + starting number (200mm)	Windscreen top left (front view) Rear window top center
2	2	50 height	black or white	Driver's name	Roof rail
3	2	360 x 308	white with black frame	Starting number plate, incl. Porsche logo, Supercup identification + title sponsor (MOBIL 1)	Left and right door
4	2	160 height	black	Starting number	Left and right door on starting number plate (3)
5	2	395,8 x 35,8	black or white	www.porsche.com/pmsc	A-pillar left and right
6	2	455 x 20	white	Instagram' + 'X' Logo @porschepulcup @porsche.customerracing	Lower window frame left and right
7	1	526 x 32	black or white	PORSCHE lettering	Rear lid, centered
8	1	256,5 x 40	black or white	GT3 Cup	Rear lid, centered
9	1	207 x 107	red-black	Flash for current interrupter+ Letter "E" for extinguisher	Front bonnet, right (front view)
10	2		red with white outline	mounting of integral two-mount rescue device	Roof
11	1	1244,5 x 133,7	MOBIL1 (gold)	MOBIL1	Windscreen top
12	1	282 x 80	BANQUE HAVILLAND original colours	BANQUE HAVILLAND	Front bumper
13	1	557 x 120	MICHELIN original colours	MICHELIN; curved sticker	Front bumper

Attachment 2 – Sticker Regulations 2024 (4/6)*

Number	Quantity	Size (in mm)	Colour	Logo/Symbol	Placement
14	2			Reservation Porsche AG	Below headlights
15	2	245 x 70	MOBIL1 (gold)	MOBIL1	Left and right front bumper
16	2			Reservation Porsche AG	Left and right front bumper
17	2			Reservation Porsche AG	Fender left and right
18	2			Reservation Porsche AG	Rear bumper left and right
19	2			Reservation Porsche AG	Sill left and right
20	2			Reservation Porsche AG	Sill left and right
21	2			Reservation Porsche AG	Sill left and right
22	2	180 x 90	ESSO original colours	ESSO	Sill left and right
23	2			Reservation Porsche AG	Side area left and right
24	1	1067 x 120		Reservation Porsche AG	Rear window top
25	2	280 x 56	MICHELIN original colours	MICHELIN	Rear bumper, left and right
26	1	245 x 70	MOBIL1 (gold)	MOBIL1	Rear bumper, centered
27	2			Reservation Porsche AG	Bucket seat in the headrest area left and right
28	1			Reservation Porsche AG	Rear of bucket seat
29	2	323 x 137		National flag	Rear side window left and right
30	2			Reservation Porsche AG PMSC Junior	lateral plates of rear wing, left and right

Attachment 2 – Sticker Regulations 2024 (5/6)*

Number	Quantity	Size (in mm)	Colour	Logo/Symbol	Placement
31	1			Reservation Porsche AG PMSC Junior	Roof tape
32	2			Reservation Porsche AG PMSC Junior	Fender front left and right
33	2			Reservation Porsche AG PMSC Junior	Side part left and right

*Subject to amendments

Please note:

1. The obligatory stickers are to be obtained from Dr. Ing. h.c. F. Porsche AG only.
2. The minimum space between stickers must be at least 30 mm.
3. The sticker positions 1-33 are strictly reserved for Porsche AG.
4. If positions 14, 16-21, 23, 24, 27, 28, 30-33 are not occupied by Dr. Ing. h.c. F. Porsche AG, they shall be available until availability is revoked. Such revocation shall be announced in good time by the Porsche Mobil 1 Supercup organisation, at least four weeks prior to the revocation taking effect.
5. All positions in direct visibility of the on-board cameras (dashboard etc.) in the interior and exterior areas of the racing car are reserved for Dr. Ing. h.c. F. Porsche AG and cannot be used by the Competitors
6. Usage of current or historic livery of Porsche Motorsport works racing vehicles is reserved for Dr. Ing. h.c. F. Porsche AG.

Exclusivity rule:

Advertising of team partners that compete with partners of Dr. Ing. h.c. F. Porsche AG, Porsche Mobil 1 Supercup and/or cooperation partners shall be prohibited. In regards to the exclusivity of the partners of Dr. Ing. h.c. F. Porsche AG following rules apply. The exclusivity rule refers to the industry sector or to the product range of a manufacturer.

Attachment 2 – Sticker Regulations 2024 (6/6)*

1. Mobil 1 is the exclusive partner of the Porsche Mobil 1 Supercup for lubricants, thus prohibiting Competitors to communicate or advertise for companies or products that are competitors of Mobil 1 lubricants.

For the area of fuels, Competitors are permitted to communicate or advertise for other companies under the following conditions and on request of Dr. Ing. h.c. F. Porsche AG:

- The product brand "fuel" has to be clearly distinguishable from the company brand, e.g. "V-Power" or "Ultimate"
- A maximum of one team with 3 race cars may communicate or advertise for one fuel brand. The date of the contract signing is pivotal.

Any fuel team sponsorship is required to be approved by Dr. Ing. h.c. F. Porsche AG prior to signature of any agreement between a Competitor and a potential fuel sponsor.

2. Michelin is the exclusive partner of the Porsche Mobil 1 Supercup. Therefore it is forbidden to Competitors to communicate or advertise for companies or products that are competitors of Michelin.

There is no exception for partners of exclusivity.

For questions or additional information, please contact the Porsche Motorsport Business Relations team, Mr Bernd Simmendinger (bernd.simmendinger@porsche.de) or Ms Andrea Hagenbach (andrea.hagenbach@porsche.de).

*Subject to amendments

Attachment 3 – Ballast weights

Ballast position on the front right side of the ballast plate mounted on the passenger seat mounting points.

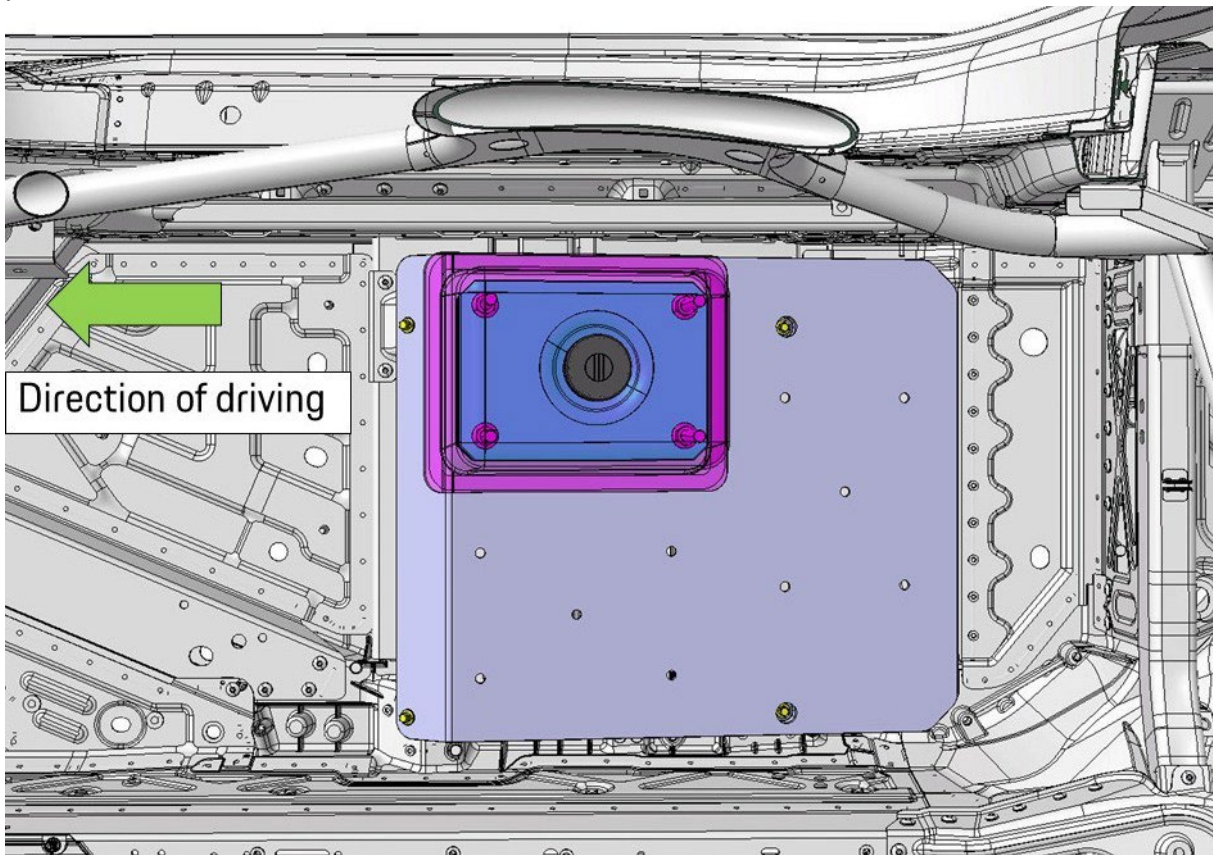

Attachment 4 – Differential lock ramp breakover angle

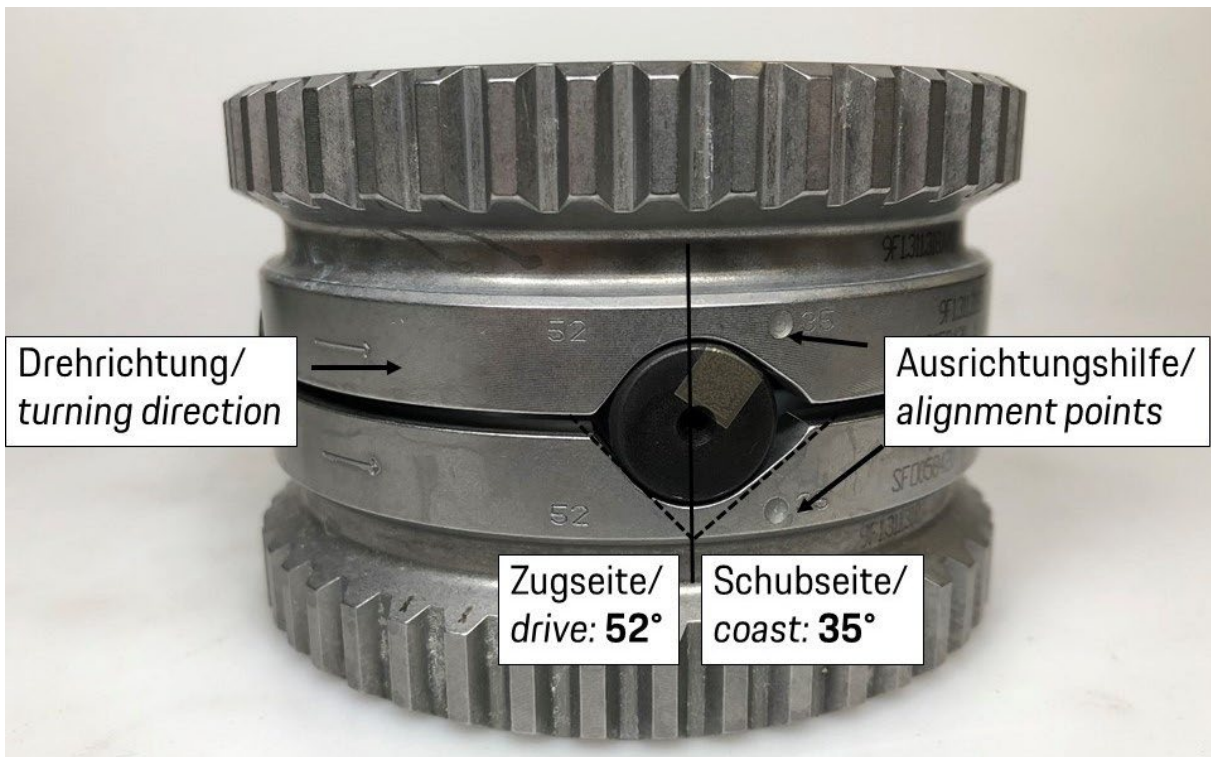

Attachment 5 – Ground clearance measuring points

Ground clearance measuring positions:

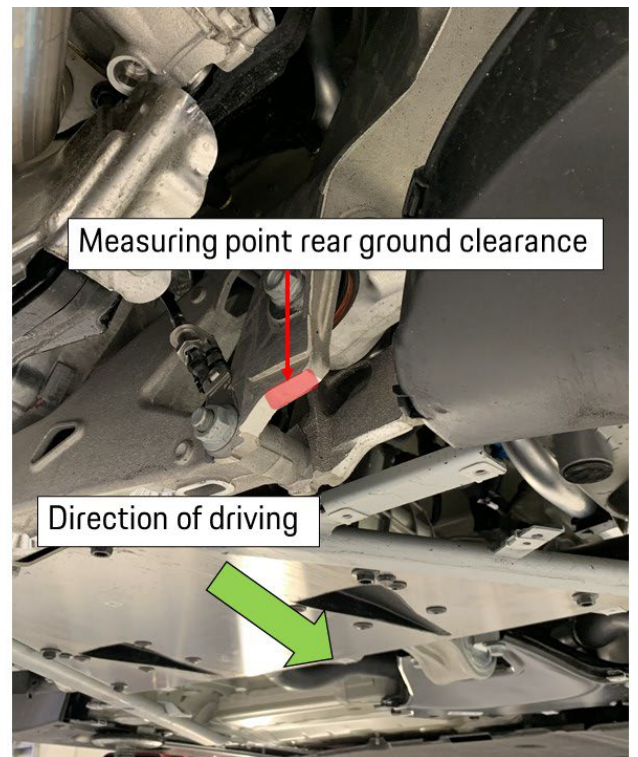
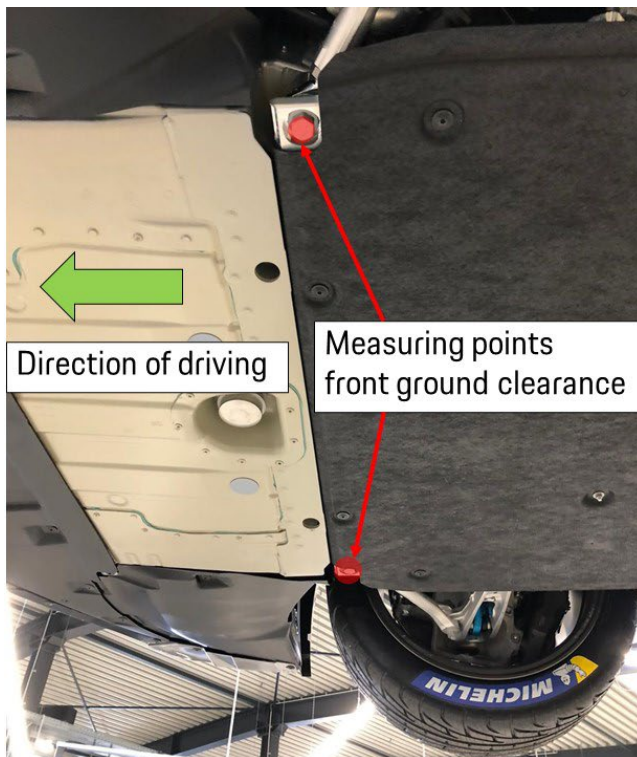
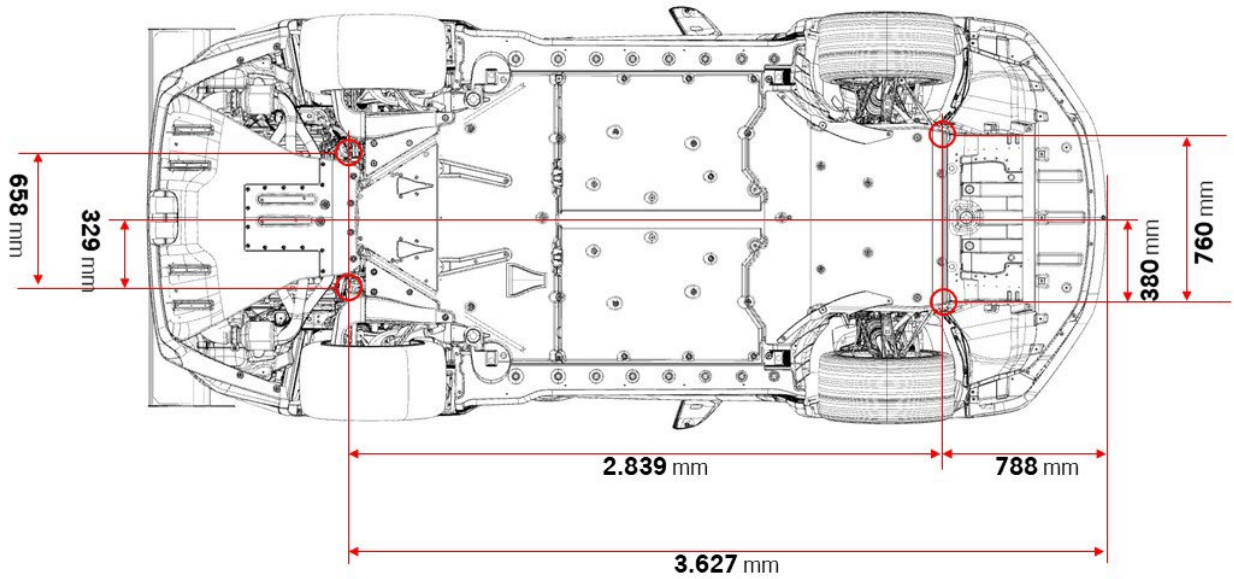

Attachment 6 – Seat padding

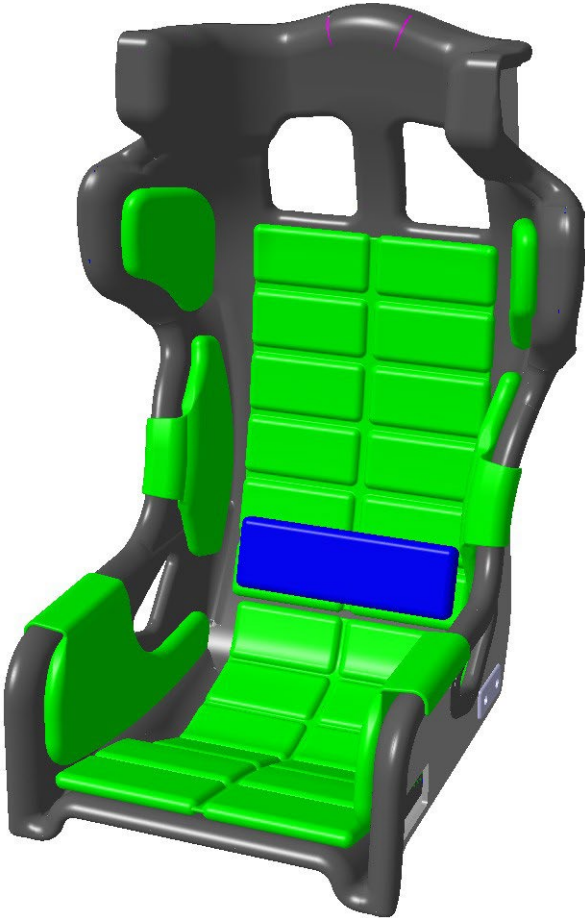

Attachment 7 – Timing Transponder Position

The transponder must be located in the centre tunnel underneath the car covered by the central underbody panel. It is only permitted to be mounted with the bracket supplied by the Series Organiser.

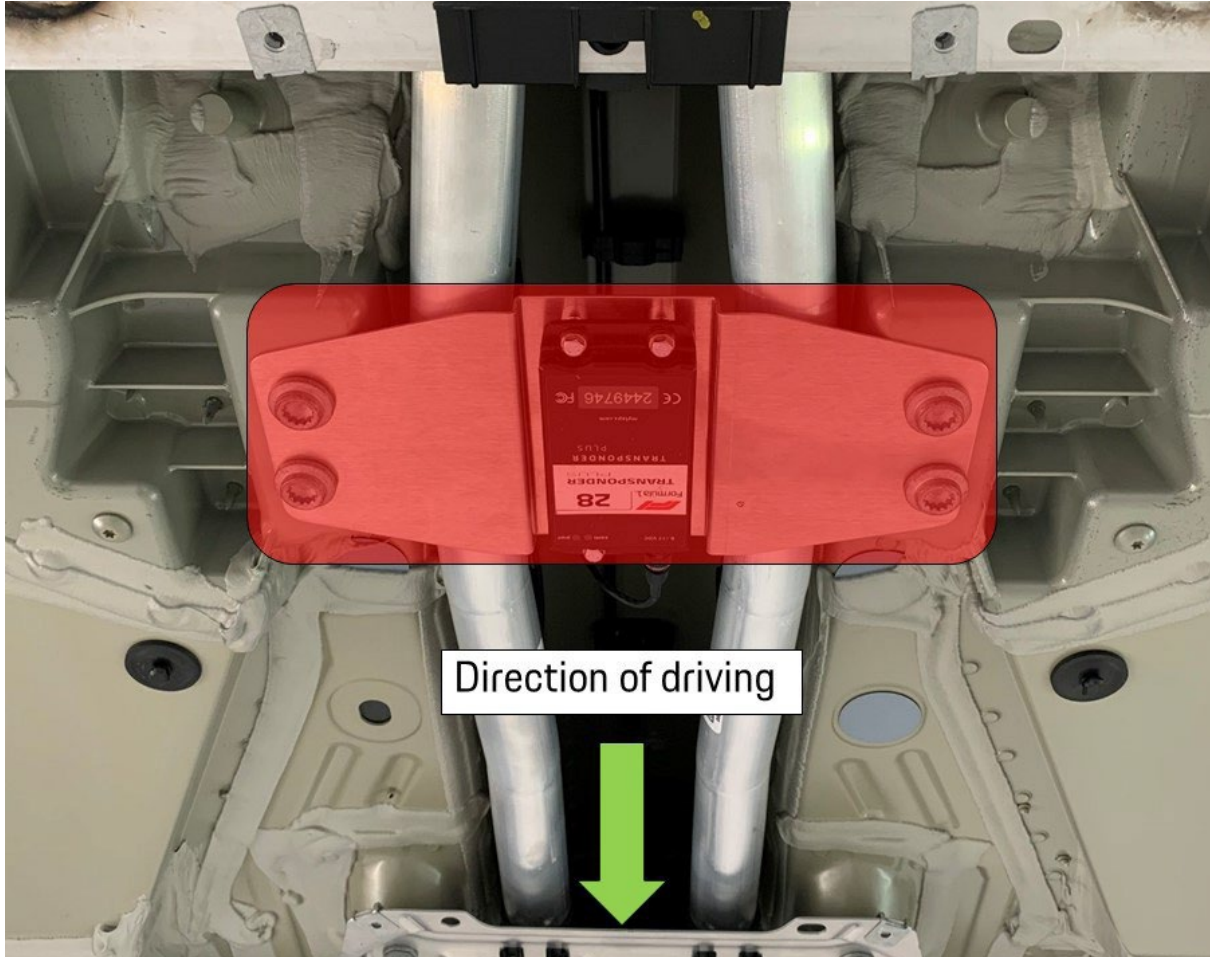

Attachment 8 – Tyre Tables

Slick tyres	For the first event in which a competition number participates		All subsequent events in which that competition number participates	
	Events with 1 Race	Events with 2 Races	Events with 1 Race	Events with 2 Races
Tyre marking for Free Practice	max. 1 set */** of new tyres Slick tyres from any previous event must not be used		Only marked slick tyres which were allocated to that competition number in a previous competition of the current Series can be used **	
Tyre marking for Qualifying/ Race	max. 2 sets of new tyres	max. 3 sets of new tyres	max. 2 sets of new tyres	max. 3 sets of new tyres
* Note 1:	Should circumstances result in the opening (operative) event being held at Monaco, 1 additional set of new tyres may be marked for the free practice session for that event.		-	
** Note 2:	For any entry of a VIP Guest Driver, the VIP Guest Team Competitor may make a written request to the Stewards for permission to mark an additional set of new tyres for the free practice session. If such permission is granted, then all lap times set by the VIP Guest Driver in the free practice session will be deleted.			

Rain tyres	For the first event in which a competition number participates		All subsequent events in which that competition number participates	
	Events with 1 Race	Events with 2 Races	Events with 1 Race	Events with 2 Races
Tyre marking for Free Practice	The use of rain tyres in free practice is unrestricted. Tyre marking is not required.			
Tyre marking for Qualifying/ Race	max. 2 sets of new tyres	max. 3 sets of new tyres	max. 2 sets	max. 3 sets

Attachment 9 – Paddock Presentation (1/5)

- (a) Throughout the course of the Series, the Series Organiser may inspect race transporters and/or support vehicles to ensure that they are of smart appearance and in good order. The Series Organiser may refuse to issue a Paddock vehicle pass to any vehicle that it deems to be unsuitable for display within the Paddock.
- (b) At the start of, and throughout, each event the competing cars and all team vehicles must be clean, of smart appearance, and in good order. The Series Organiser reserves the right to refer Competitors not meeting this requirement to the Stewards for possible penalty and to require immediate rectification so that this regulation is fulfilled to its satisfaction.
- (c) Prior to each event Competitors will be issued by the Series Organiser with a specific time and paddock location to park up their race transporters. This will be included within the Official Event Schedule. This park up time must be adhered to unless the express permission of the Series Organiser has been obtained to park up at a different time. Verbal permission from circuit employees will not be accepted. Access to the Paddock for the purpose of parking outside a specified parking up time will be forbidden.
- (d) The paddock, team areas and areas within team awnings must always be presented to the highest standard. They must be kept free of litter, damaged body parts, unused equipment and the like.
- (e) The movement of cars, equipment, trolleys, etc., around the paddock must be done with care and due regard to the open nature of the paddock and the presence of guests and supporters.
- (f) Only small two- and four-wheeled powered paddock vehicles which have been issued an event pass may be used within the paddock. These vehicles may only be used during authorised times and when driven by a current full road traffic licence holder for race team related business. Recreational use is strictly prohibited.
- (g) Competition cars may only be moved in the pits or paddock with a current full road traffic licence holder seated in the Driver's position and in control of the car.
- (h) A speed limit of 10 kph applies in the paddock at each event.
- (i) It is a condition of use of paddock vehicles that third party insurance is in place. Competitors are reminded that it is a criminal offence for any person to ride or drive any motor vehicle on the roads or other public areas under the control of the venue promoters unless they are covered by a minimum of third party insurance.
Any Team considered by the Series Organiser, in its absolute discretion, to be exhibiting unsuitable advertising may be asked to withdraw it immediately.
- (j) The application and placement of a provided platform signet must be in accordance with the existing Porsche Motorsport Communication Guidelines for Teams.

Each Competitor is required to meet the following setup instructions for the paddock:

Attachment 9 – Paddock Presentation (2/5)

Mandatory items:

Flags

Any race transporter/support vehicle parked in the paddock must have two flag poles fitted, on the rear end of each vehicle, protruding no more than 4 metres from the top of the vehicle. The flag poles must fly the combined Porsche Mobil 1 Supercup and Team Logo flag as well as the Driver(s) nationality flag(s). The flags need to be mounted to a vertical and horizontal flag pole in order to guarantee a proper set up.

Please see the drawing below for the exact set up.

Flag measurements:

- Total width: 1500 mm; Maximum logo width 1200 mm
- Total height: 1000 mm
- Reserved Space – 150 mm from each side in each corner

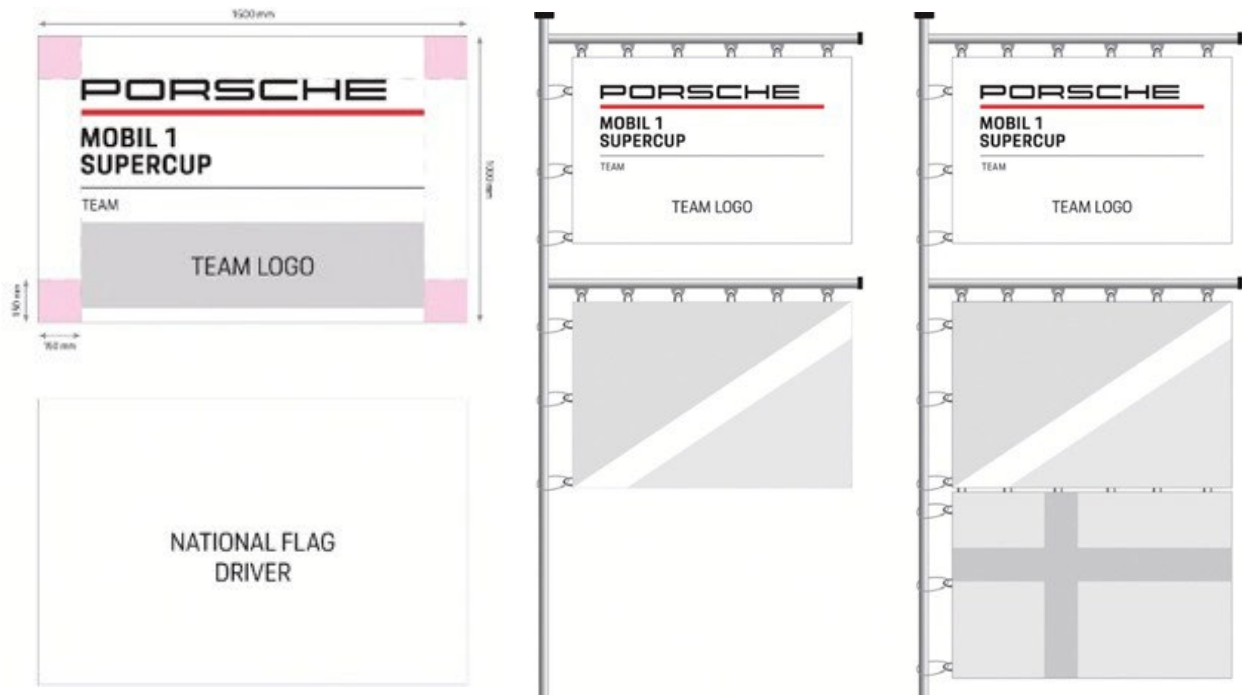

Attachment 9 – Paddock Presentation (3/5)

Example for a two car team:

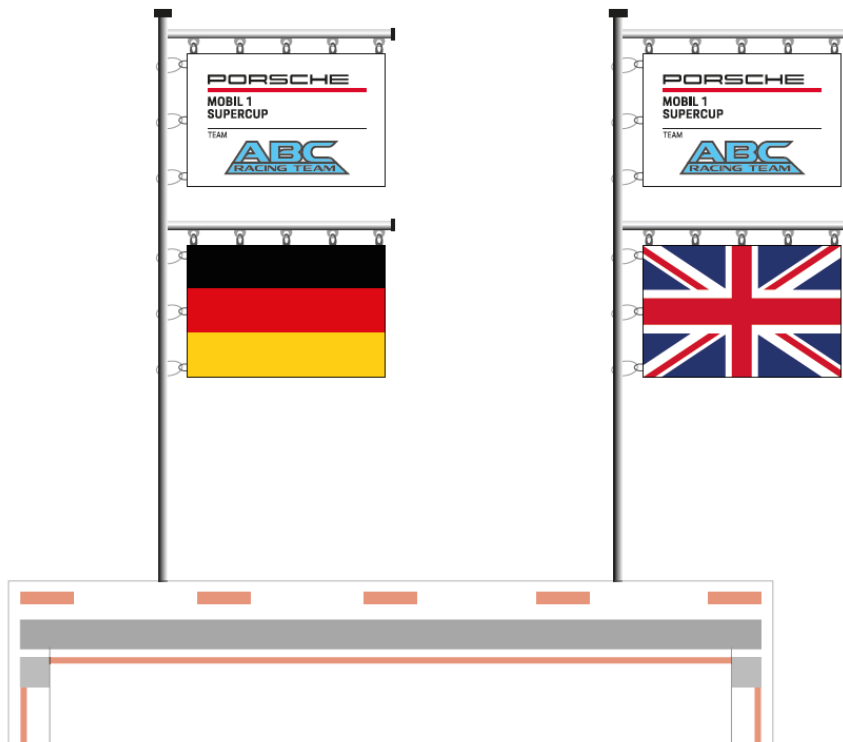

Example for a three car team:

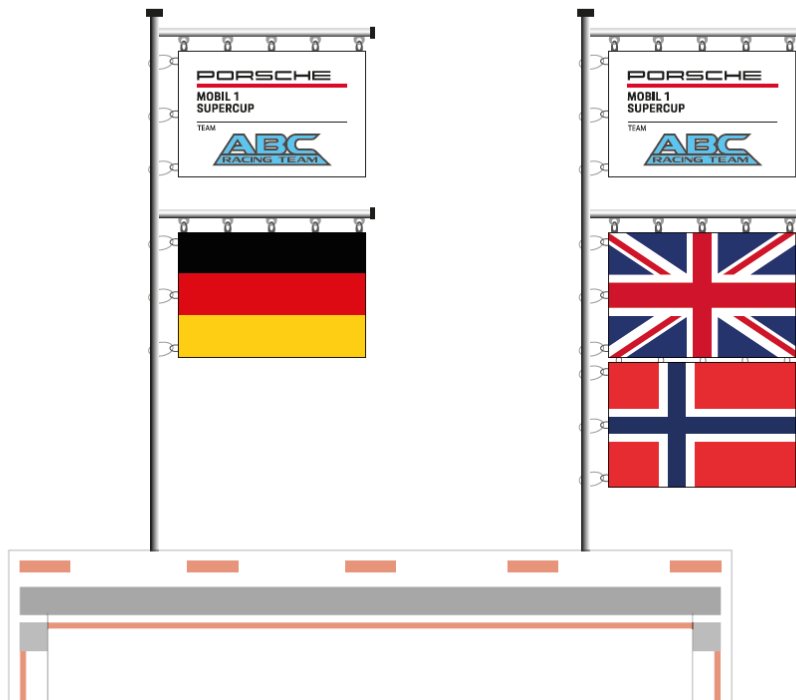

Attachment 9 – Paddock Presentation (4/5)

Tent/Awning

Each Team is required to brand the top of the front of their awning with their Team logo as well as the competition numbers of the cars parked in their awning. The following technical drawing includes the instructions, such as positioning, and measurements of the elements required. The Team logo and competition numbers are mandatory. It is also mandatory to have the top of the awning (red triangle) displayed in team colours. Please refer to the examples below for more detail.

Technical drawing:

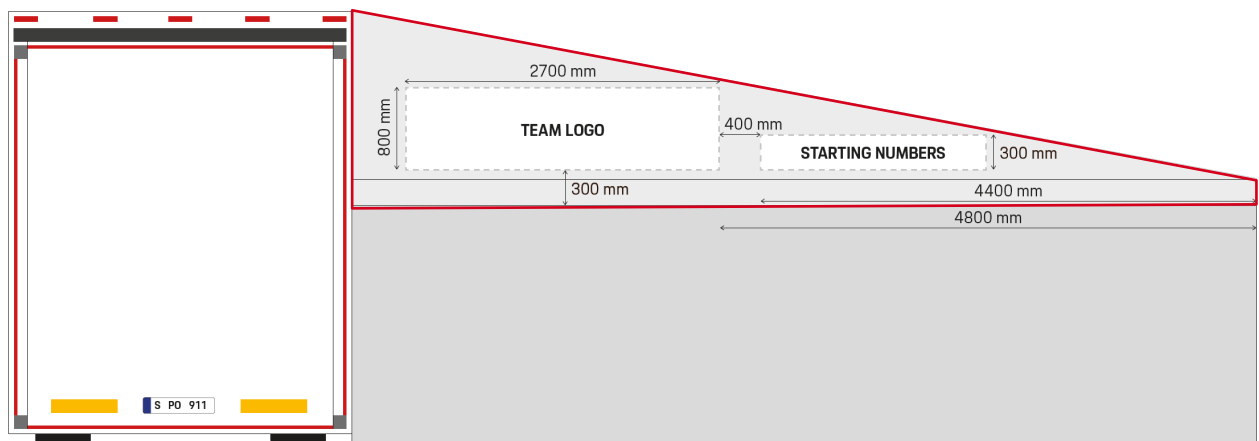

Logos

Max size: 800 x 2700 mm

Positioning of Logo:

4800 mm outer edge of tent (right or left, depending on the set up of the awning) 300 mm lower edge of tent

Competition Number:

Number height: 300 mm

Font: Porsche Next bold (118 pt) Colour: has to fit logo colours

Positioning of numbers:

4400 mm outer edge of tent (right or left, depending on the set up of the awning) 300 mm from lower edge of tent

Attachment 9 – Paddock Presentation (5/5)



Attachment 10 – Table of Penalty Guidelines (1/3)

Offence	Regulation	Practice	Qualifying	Race	Points
GENERAL					
Not attending or too late to Drivers Briefing	CR 11.2	EUR 300 minimum (EUR 500 minimum subsequent times). Must be briefed before going on track			1
Disobeyed marshals/officials' instructions	CR 3.3	EUR 500 / deletion of lap times		Drive-through	1-2
Did not respect the 3-minute signal	CR 13.8			5/10 seconds time penalty	0
Teams did not clear grid before 1-minute signal	CR 13.8			5/10 seconds time penalty	0
Not wearing Michelin cap at podium	CR 17.5			EUR 2,500	0
Display of unauthorised sponsorship badges at podium	CR Tech 1.10, Attachment 1			EUR 2,500	0
Failure to attend post session Driver weighing	CR Tech 1.6	Deletion of all lap times		Disqualification	0
TECHNICAL					
Underweight	CR Tech 1.6		Deletion of all lap times	Disqualification	0
Contravention of regulations regarding wheels & tyres	CR Tech 2.7	Deletion of all lap times	Deletion of all lap times	Disqualification	0
PIT					
Reversed car under own power in pit lane	CR 18.3(a)	Drop of 5 grid positions		Drive-through	2
Speed over 60kph in pit lane	CR 18.2(a)	Fine EUR 100 per kph or Drop of 3/5 grid positions (< 70/70>)		10 seconds time penalty or Drive-through	1-2
Crossing white line at pit entry or exit	CR 18.3(b)	Drive-through penalty in session, Reprimand or Drop of 3/5 grid positions		5/10 seconds time penalty or Drive-through	1-2
Breach of Parc Fermé regulations	CR 12.2		Deletion of lap times	Disqualification	0

The above penalties are guidelines which will be considered by the Stewards. However, the Stewards may impose any penalty they deem appropriate for any breach of the regulations.

Attachment 10 – Table of Penalty Guidelines (2/3)

Offence	Regulation	Practice	Qualifying	Race	Points
START					
Unauthorised practice starts	CR 18.3(i)	Drop of 3/5 grid positions		Drive-through	1
False start	CR 13.9			5/10 seconds race time penalty	1-2
Overtook before the re-start of the race (Safety Car)	CR 13.12			5/10 seconds time penalty or Drive-through	1-2
FLAGS					
Did not slow down under Yellow flag	CR 18.3(c)	Drop of 3/5 grid positions		10 seconds time penalty or Drive-through	1-2
Did not comply with Blue flag	CR 18.3(c)	Reprimand	Drop of 3/5 grid positions	5/10 seconds time penalty or Drive-through	1-2
Overtook under Yellow flag	CR 18.3(c)	Drop of 5/10 grid positions		10 seconds time penalty or Drive-through	1-3
Failed to respect Black & Orange flag	CR 18.3(c)	Deletion of all lap times		Disqualification	2
Did not comply with Red flag	CR 18.3(c)	Deletion of all lap times		Disqualification	2-4
Passed Chequered flag more than once	CR 18.3(j)	Reprimand or Drop of 3/5 grid positions		Reprimand or Drop of 3/5 grid positions	1-2

The above penalties are guidelines which will be considered by the Stewards. However, the Stewards may impose any penalty they deem appropriate for any breach of the regulations.

Attachment 10 – Table of Penalty Guidelines (3/3)

Offence	Regulation	Practice	Qualifying	Race	Points
DRIVING STANDARDS					
Caused a collision	CR 18.3 b)	Reprimand or Drop of 3/5 grid positions		Reprimand, 5/10 seconds time penalty or Drive-through or Stop-and-go (or Drop of grid positions if Driver did not finish the race)	1 - 3
Forcing another Driver off the track	CR 18.3 b)	Reprimand or Drop of 3/5 grid positions		Reprimand, 5/10 seconds time penalty or Drive-through or Stop-and-go (or Drop of grid positions if Driver did not finish the race)	1 - 3
Overtaking another car behind the Safety Car	CR 13.12			5 /10 seconds time penalty or Drive-through	1 - 3
Driving unnecessarily slowly, erratically or in a manner which could be deemed potentially dangerous to other Drivers	CR 18.3 b)	Reprimand or Drop of 3/5 grid positions		5/10 seconds time penalty or Drive-through or Stop-and-go	1 - 3
Impeding another car	CR 18.3 b)	Reprimand	Drop of 3/5 grid places	5/10 seconds time penalty or Drive-through	1 - 3
Left track and did not re-join at the same place or rejoined in an unsafe manner	CR 17.9 CR 18.3 b)	Reprimand or Drop of 3/5 grid positions		5/10 seconds time penalty or Drive-through or Stop-and-go	1 - 3
Exceeded Track Limits	CR 17.9 CR 18.3 b)	Deletion of relevant lap times and Reprimand or Drop of 3 grid positions for repeat offences		5/10 seconds time penalty for repeat offences. Drive-through for continued offences	1 - 2
Gaining an unfair advantage (e.g. by overtaking off track without returning the position)	CR 17.9 CR 18.3 b)	Loss of relevant lap time		3/5 seconds time penalty	1-2

The above penalties are guidelines which will be considered by the Stewards. However, the Stewards may impose any penalty they deem appropriate for any breach of the regulations.

Attachment 11 – Alternative Part Number Reference Table

Part	Number	Alternative Number (previous model)
AUXILIARY WEIGHT 2KG/6MM	9F1801141	99150484800
AUXILIARY WEIGHT 3,5KG/10MM	9F1801141A	99150484801
AUXILIARY WEIGHT BIG 6,8KG/20MM	9F1801141B	99150484802
COVERING AUXILIARY WEIGHT	9F1801575	9915048659B
KNURLED NUT COVERING	WHS001903	9915048529B
WHEEL NUT LEFT	9F1412157	9973313079A
WHEEL NUT RIGHT	9F1412158	9973313089A

**20
24**

porsche.com/pmsc

© Dr. Ing. h.c. F. Porsche AG, 2024

The Porsche wordmark and Porsche crest are registered trademarks of Dr. Ing. h.c. F. Porsche AG.

Dr. Ing. h.c. F. Porsche AG is a company registered at Stuttgart, Germany.
Registry court: District Court Stuttgart, Germany
HRB no. 730623

Dr. Ing. h.c. F. Porsche AG
Porsche Mobil 1 Supercup Organisation
Porschestraße 911
71287 Weissach
Germany

Edition 01/2024